

AFMAN 10-100

Airman's Manual

1 June 2004

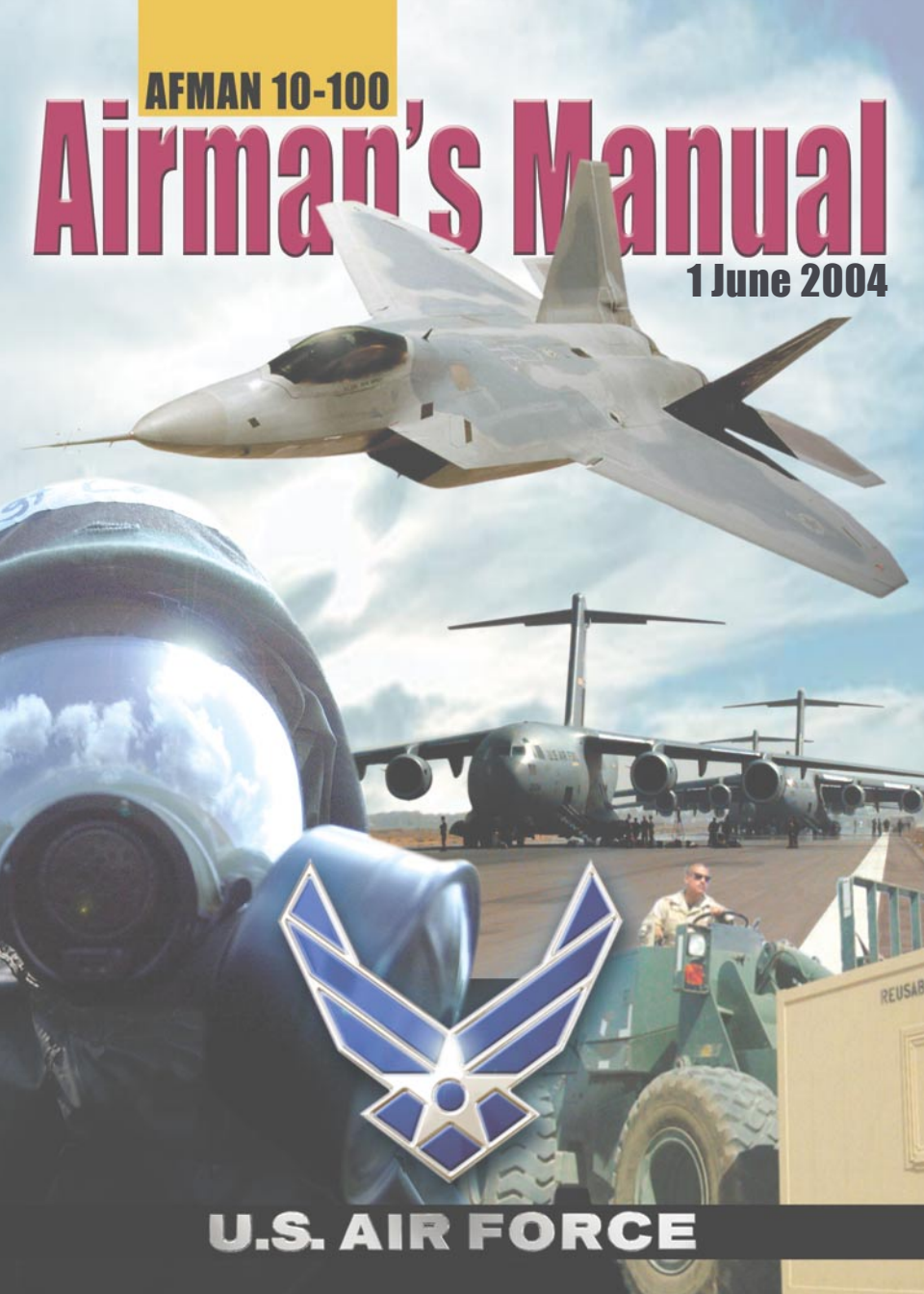

U.S. AIR FORCE



Operations

AIRMAN'S MANUAL

COMPLIANCE WITH THIS PUBLICATION IS MANDATORY

NOTICE: This publication is available digitally on the AFDPO WWW site at:
<http://www.e-publishing.af.mil>

OPR: HQ AFCESA/CEXR (Mr John Thornton)

Certified by: HQ USAF/ILE
(Maj Gen L. Dean Fox)

Pages: 262

Supersedes AFMAN 10-100, 1 August 1999

Distribution: F

This manual applies to active duty, reserve, national guard, emergency essential civilian, and emergency essential contract personnel. It compiles war skill tactics, techniques, and procedures from many sources into a pocket-sized, quick reference guide. This manual implements AFD 10-25 *Full-Spectrum Threat Response* and incorporates provisions of AFMAN 10-2602 *Nuclear, Biological, Chemical, and Conventional (NBCC) Defense Operations and Standards*, as well as portions of AFH 32-4014, Vol 4, *USAF Ability to Survive and Operate Procedures in a Nuclear, Biological, and Chemical (NBC) Environment* that is rescinded upon publication of this manual.

SUMMARY OF REVISIONS

This revision includes revised strategies and procedures for the way Aerospace Expeditionary Forces (AEF) will prepare, fight, and operate on the NBCC battlefield. Operational updates include changes in improvised explosive devices, counter-chemical warfare operations, contamination avoidance strategies, warning and notification signals/sirens, and the addition of the M45 Land Warrior Chemical-Biological Mask. Informational updates include embedded media journalists, self-aid buddy care, chemical protective overgarments, mask wear and inspection, and the Split-MOPP concept. Two new sections were added, Quick Reference and Critical Information Checklists, to reinforce AEF knowledge and confidence, and to facilitate effective actions under stressful situations.

This manual issued to:

control number:

Rank _____ Name _____

Unit _____ Phone _____

tear out along perforation

AFMAN 10-100 Airman's Manual issued to:

1 June **2004**

Rank _____ Name _____

control number:

Unit _____ Phone _____

Signature _____

This page intentionally left blank.

An Introduction for Airmen



“Today, there’s nothing you could be doing with your lives that is any more meaningful or any more appreciated than what you are doing. Be proud!”

General John P. Jumper
Chief of Staff, USAF



Every Air Force member is an “expeditionary Airman.” That means you must stay ready to deploy anywhere in the world on short notice. This manual doesn’t contain everything you must know. It doesn’t focus on the integrated multiservice or multinational nature of combat operations. It doesn’t replace regulations or local procedures you’ll need to follow. This manual does, however, cover basic warfighting skills and points of knowledge. Our intent is to help you successfully complete the mission. The tasks outlined in this manual apply at both deployed and home station locations. Keep the *Airman’s Manual* close, use it while training and exercising for contingencies and deployments. Refer to it often... you’ll need it.



Table of Contents

An Introduction for Airmen	i
Table of Contents	ii

Section 1 Staying Ready

Personal Affairs	2
Predeployment Maintenance Checklist	4
Mobility Bags	5
Personal Bag	6
Host Nation Sensitivities	7

Section 2 Deploy

Prepare for Deployment	10
Team Integrity and Accountability	11
Rules of Engagement (ROE)	12
Law of Armed Conflict (LOAC)	13
Handling News Media	15
OCONUS Legal Concerns	18
Force Protection Condition (FPCON)	19
Attack Warning Signals for Nuclear, Biological, Chemical, and Conventional Medium and High Threat Areas	20
Individual Protective Equipment (IPE)	21
Battle Dress Overgarment (BDO)	22
Chemical Protective Overgarment (CPO)	24
Mission Oriented Protective Posture (MOPP)	27
MOPP Options	33
Split-MOPP Concept	34
Lifting and Carrying Safety	36

Section 3 Employment

Arrival at Deployment Location	38
Arrival Actions	40
The Improvised Explosive Device (IED) Threat	42
Health Concerns During Deployment	46
Other Concerns	48
Mental Health	50
Deployable Shelters	51
Fire Safety	52
Expedient Firefighting	53
Waste Control	55
Contaminated Waste Control and Disposal	56
Food Consumption	58
Resources Protection and Crime Prevention	59
Passive Defense	60
Expedient Hardening	62
Camouflage, Concealment, and Blackout	63
Defensive Fighting Position (DFP)	65
Contamination Avoidance and NBC Pre-Attack Preparation	67
Command and Control	70
Field Communications	72
Anti-Terrorism Force Protection Measures ..	73
Be Suspicious	74
Terrorist Threats and Vehicles	75
Pre-Attack Actions	77

Additional Attack Preparations Under Alarm Yellow	80
---	----

Section 4 Fight

Integrated Base Defense (IBD)	82
Security Procedures	84
Challenging Intruders	85
Challenge and Password	88
Handling Prisoners and Defectors	89
Audible and Visual Warnings	91
Attack Warning	93
Reporting an Attack	95
S-A-L-U-T-E	95
Reactions to Flares	97
Vehicle and Equipment Protection, Marking, and Decon	98
Convoy Procedures	100
Convoy Attack Procedures	100
Weapons Skills—Rifle	102
Care and Cleaning	112
Weapons Decontamination	114
Weapons Skills—Pistol/M9	117

Section 5 Survive

Alarm Black—Attack Is Over, Initiate Base Recovery	126
Post-Attack Reconnaissance	126
Unexploded Ordnance (UXO)	128
Reporting Unexploded Ordnance	131
Contamination Control	132
M8 Chemical Agent Detection Paper	134
M9 Chemical Agent Detection Paper (Tape)	137

Nuclear Attack/Radioactive Individual Protective Actions	138
Nuclear and Biological Protection	139
Biological Agent Individual Protective Actions	141
Biological Warfare and Biological Terrorism	142
Operational Differences Between Chemical and Biological Warfare Agents	144
Chemical Agent Individual Protective Actions	145
Nerve Agents	145
Nerve Agent Antidote Injectors	146
Blister Agents	148
Toxic Industrial Material (TIM)	149
Shelter-In-Place	150
MCU-2 Series Protective Mask	153
M45 Land Warrior Chemical-Biological Mask	162
Canisters and Filters	168
Mask Second Skin	169
Drinking Through the Mask	171
Levels of Chemical Decontamination	173
M291 Skin Decontamination Kit	174
M295 Individual Equipment Decontamination Kit	175
Casualty Collection	176
Casualty Care in an NBC Contaminated Environment	177
Basic Lifesaving Steps	177
Combating Heat Illness and Cold Injury	182
Dehydration	183
Heat Exhaustion	183
Heat Stroke	185
Heat Injuries	186

Cold Injuries	187
Emergency Life-Saving Equipment	188
Handling Human Remains	189
Rights as a Prisoner of War	190
Code of Conduct	193

Acronyms and Definitions	220
--------------------------------	-----

Index	223
--------------------	-----

Section 6 Quick Reference

Phonetic Alphabet/Prowords	196
Procedure Words (PROWORDS)	197
Wind Chill Chart	199
Contamination Control Area (CCA) Readiness	200
Contamination Control Area (CCA) Aircrew	201
Nuclear, Biological, and Chemical (NBC) and Unexploded Ordnance (UXO) Hazard Markers	202
Nuclear, Biological, Chemical, and Conventional (NBCC) Hazard Markers	203
10-Foot Rule (Chemical Warfare).....	204
IED Reporting and Evacuation	205
MCU-2 Series Mask Inspection	206
M45 Mask Inspection	208
Serviceable Tag-Materiel, DD Form 1574	212
Control Tower Signals	213
Battle Dress Overgarment (BDO) and Chemical Protective Overgarment (CPO) Accessory Checklist	214
Quick MOPP	215
Work Rest Cycles and Fluid Replacement Guidelines	216
Square Grid Matrix	217
Reading a Grid Map	218
Chemical Agent General Information.....	219

EXTRA FEATURE: Open back cover for access to critical items

Critical Information Checklist

Post Attack Actions	1
UXO Survey	2
USAF Unexploded Ordnance (UXO) Recognition and Reporting Chart ...	3
Nuclear Attack Radioactive Individual Protective Actions	8
Nerve Agent Poisoning and Antidote	10
Shelter In-Place Actions	13
Life Saving Steps	17
Shock	18
Tourniquet	19
Abdominal Wound	20
Bleeding	20
Common Injury Treatment	21
Spinal/Neck/Head Injury	21
Eye Injury	22
Chest Wound	22
Fracture	23
M16 Jammed	24
M9 Jammed	25
Important Phone Numbers and Quick Reference	26

Section 1

Staying

Ready



Personal Affairs

Ref 10 United States Code (USC), Sec 1044, AFI 51-504

The military is a dangerous profession. You must keep your personal affairs in order at all times. Avoid problems later by effectively managing your personal matters BEFORE you deploy.

Finance

- Obtain a myPay Personal Identification Number to access your military pay account (Leave and Earning Statement, Pay Changes, Taxes, Thrift Savings Plan) via the Defense Finance and Accounting Service myPay website at <https://mypay.dfas.mil>
- Settle any Government Travel Card bills
- Upon notice of deployment consider establishing “accrual travel payments” to help you pay your travel expenses while deployed. Contact Finance or visit the Virtual MPF website at <http://www.afpc.randolph.af.mil>



Legal

Periodically review your legal documents and keep them up-to-date. Marriage, divorce, births, deaths, and changes in wealth are significant events that affect your legal interests.

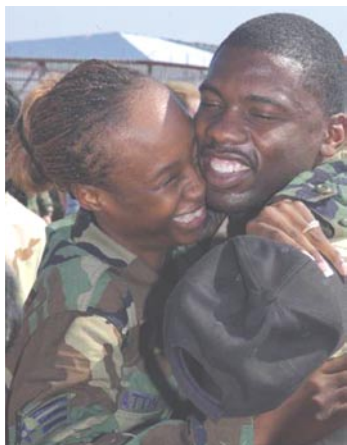

Will—Legal instrument everyone should have that allows you to:

- Declare who should carry out (or “execute”) the provisions of your will
- Dispose of your property after death
- Name guardians to raise your minor children and manage any property you leave to them

Life Insurance—Your life insurance policy, including Serviceman’s Group Life Insurance, pays money to named beneficiaries upon your death. It’s a contract between you and your insurer. Because of that, the provisions of your will

generally do not impact insurance payouts. You should discuss with legal assistance providers the risks/dangers of designating “by law” distribution of insurance proceeds, compared with specifically naming individuals. Make sure your policy is the correct type and the value you need.

Power of Attorney (POA)—Lets you designate someone else to perform one or more legal acts on your behalf for a set period of time. POAs are powerful documents. Make sure the people you choose to execute your POA are trustworthy, have good common sense, and clearly understand what you desire concerning the matters you ask them to conduct. No company or agency is required to accept or honor any POA. Prior to deployment, check with the company/agency with which your designee will be doing business, and ensure the POA meets its needs. Three types of POAs are:

- **General**—a designee may do virtually anything you can legally do. This is an extremely powerful document!
- **Special**—a designee may carry out only a specific matter such as sell a vehicle, buy or sell real estate, or ship/store household goods.
- **Health Care**—a designee may make health care decisions if you’re unable to do so because of injury, illness, or the effects of medication.

Uniformed Services Employment and Re-employment Rights Act (USERRA)—This law assists anyone, particularly reservists and guardsmen, get their jobs back after deployment. USERRA also addresses issues such as seniority, leave, pension plans, and continuing health care coverage for members and dependents while deployed.

Soldiers and Sailors Civil Relief Act (SSCRA)—A comprehensive law that provides protection of many different types to members while on active duty, from capping interest rates on pre-service loans to postponing civil court cases.

Taxes—Your activation and deployment to certain areas of the world may greatly impact your federal and/or state income tax filing and refund. You may be able to exclude your income earned during a deployment or you may be entitled to an extension of the filing deadline.

Predeployment Maintenance Checklist**General**

- Chaplain and religious concerns
- Family support center
- Child care center
- Family care certification (AF Form 357)
- Emergency contact information
- Emergency data card (DD Form 93)
- Real estate/rent
- Vehicle
- Pets
- Education
- Voter registration
- Safe deposit box
- Restricted area badge
- Weapons qualification (AF Form 522)
- Government and flightline drivers license

Legal

- Will / Living will
- Life Insurance:
 - Serviceman's Group Life Insurance
 - Private policy
- Power of Attorney:
 - General
 - Medical/Special
- Passport

Health Care

- Prescription medicine
- Dental care
- Corrective lenses:
 - Clear
 - Sunglasses
 - Protective mask
- Immunizations
- Preventive/predeployment health assessment
- Force Health Management (Public Health)

Finance

- Installment loans
- Allotments
- Automatic payments
- Investment portfolios
- Tax and accounting
- Government Travel Card
- Keep a supply of extra personal checks on hand

**Use as a reference
to help you stay prepared.**



Mobility Bags

Depending on your specialty, duty station, and deployment destination, you'll be issued any combination of the mobility bags listed here.

A-Bag, General Support—Includes basic items such as helmet, web belt, body armor, sleeping bag, canteen kit, mess kit, and other support items.



C-Bag, Chemical Defense—Includes chemical warfare defense ensembles, protective mask, mask filters, gloves, hoods, boots, detection papers, and other chemical defense items.



B-Bag, Cold Weather—Includes basic items such as parka, gloves, boots, socks, and other cold weather items.



D-Bag, Aircrew Chemical Defense—Includes specialized in-flight protective equipment (coveralls and mask, mask filters, blower, gloves, hoods, boots, detection papers/kits, and other chemical defense items.)

Personal Bag

Along with mobility bags, you must prepare a personal bag that contains mission essential items you must take based on the most probable deployment scenario. Since a Tactical Field Exchange may not be operational at your deployed site, you should pack a 30 to 45 day supply of personal consumable items to help you through your initial stay.

Here are some things your unit will require you to pack and some additional items you may wish to take when they're authorized. Follow your unit deployment checklist for mandatory items and quantities.



Prepare a personal bag.

- Uniform sets
- Civilian clothing
- Athletic clothing
- Cold/Wet weather gear
- Undergarments and socks
- Clothes hangers
- Waterproof bags
- Sunblock, lip balm, lotions, insect repellent
- Towels, washcloths, premoistened towelettes
- Mirror, comb/brush, toothpaste, toothbrush, floss, toothpicks, shampoo, soap, razor, tissues, hygiene products
- Snacks, gum, candy, antacids, vitamins, aspirin, prescription medicines
- Extra prescription glasses and sunglasses
- Radio, audio player, alarm clock, wristwatch, flashlight, spare batteries, camera, film
- Zipper bag with powdered laundry detergent (but laundry facilities may not be immediately available)
- Religious material, magazines, crossword puzzles, photos, paperbacks, study guides, stationary kit, address book
- Some emergency cash, a checkbook, and a credit card (Transport aircraft can be diverted or break down en route... be prepared!)

Host Nation Sensitivities

Learn as much as you can about where you're going before you deploy—it may be profoundly different than what you're accustomed to in the United States. Also, don't be surprised if you learn that some of your rights, freedoms, and customs aren't recognized or are altogether unacceptable in some global regions. You have a lot of things to remember, so when you study the deployment region, consider these important issues.

- Religion—not all countries guarantee religious freedom and displaying some religious icons may be offensive to our hosts
- Dress and Appearance—what might seem acceptable in the US may be offensive or even illegal somewhere else
- Literature—beware of anything that might be construed as pornographic material or illegal in certain regions
- Food Items—many countries stringently control what you can and can't bring in, especially tobacco and alcohol
- Gender Specific Laws and Customs—women and men may not be granted equal rights where you're going
- Social Customs—learn the do's and don'ts of the host nation



● Recent deployment regions.

The US State Department's web site at <http://www.state.gov> is the single best source to find answers to many questions you may have. Some other good sources are your installation legal office, the Air Force Office of Special Investigations (AFOSI), and Public Affairs. Research all of them—remember, you'll be a guest of the host nation and your actions will directly reflect upon the Air Force and the United States.



Section 2

Deploy



Prepare for Deployment

There are many things you can do to prepare for a deployment even days, weeks, and months before you may be tasked to depart. Don't wait until the final moment to prepare. Here are a few of those actions you can do early:



C-17.

Home Station or Prior to Deployment

- Review
 - Force Protection Condition (FPCON) actions
 - Deployment actions such as medical preparations, mobility bag issue, and personal requirements
 - Attack Warning Signals
 - Alarm Conditions
 - Mission Oriented Protective Postures (MOPP)
 - Individual protective actions
 - Self-aid and buddy care actions
 - Unit pre-conflict and attack actions checklists
- Carry or have immediate access to this manual
- Inspect your individual protective equipment (IPE), paying particular attention to the mask. If you have questions on mask serviceability, contact your local CE Readiness Flight
- Verify you have your eyeglasses and protective mask inserts
- Carry several permanent black markers in your IPE
- Complete protective mask fit test and mask assessment for the mask you're issued

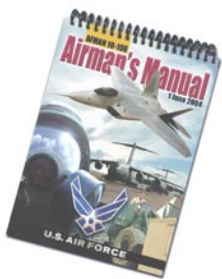

Here are some tips to follow once you're en route:

- Determine FPCON, Alarm Condition, and MOPP at each en route stop
- Carry your IPE on the aircraft or vessel if you're deploying to a NBCC medium or high threat area
- Keep your IPE at hand during en route stops (when directed)
- Review this manual



Team Integrity and Accountability

Ref AFI 10-403, AFI 10-215

Nearly every Air Force member may be tasked to deploy with very little notice to support all types of contingency operations around the globe. Depending on the operational need, you

may be tasked to deploy with your unit, in a small group, or alone.

If you deploy in a group, you'll form up in deployment chalks that are traditionally associated with an aircraft mission number. Usually, you'll first assemble at your unit then shuttle with your group to a personnel deployment function (PDF.) PDFs offer you one last-chance opportunity to ensure you have your affairs in order and your medical needs met before you depart. Most PDFs provide representatives from finance, legal, family support, medical, personnel, and the chaplain's office to assist you. During processing, AFOSI, medical, and weather will also brief you on the latest information for your destination. Before leaving the PDF, a troop commander (officer or enlisted) will be assigned to your chalk (this could be you). It's the troop commander's responsibility to hand carry a personnel and equipment accountability kit for that chalk to the deployed location.



Personnel deployment function briefing.

Rules of Engagement (ROE)

Ref CJCSI 3121.01A

Command authorities issue ROE that describe the circumstances and limitations under which we can start or continue military operations. You'll find ROE incorporated in almost every operations plan and operational order.



ROE tailored for each mission.

Commanders use ROE to ensure operations follow national policy goals, mission requirements, and the rule of law. You must understand, remember, and apply the Law of Armed Conflict (LOAC) and ROE while performing your duties.

In armed conflict, the LOAC and ROE specifically tailored for each mission or area of responsibility provide guidance on the use of force.

The purpose of the US standing ROE is to implement guidance on the application of force for mission accomplishment and the exercise of the inherent right and obligation of self-defense.

Individual self-defense is the inherent right to use all necessary means available and to take all appropriate actions to defend oneself and US forces in one's vicinity from a hostile act or demonstrated hostile intent.



Defense is an inherent right.

Understand that:

- ROE questions and concerns should be properly elevated up the chain of command for resolution
- Failure to comply with ROE may be punishable under the Uniform Code of Military Justice

Law of Armed Conflict (LOAC)

Ref CJSI 3121.01A, AFI 51-401

Every military member must obey and follow the LOAC. The fundamental purposes of LOAC are to prevent unnecessary suffering and the maintenance of a well-disciplined military force. LOAC includes the Geneva and Hague Conventions, other treaties, and customary international law. LOAC must be followed during all military operations. Failure to comply may be punishable under the Uniform Code of Military Justice. Here are some things to remember:



Every military member must follow LOAC.



Use amount of force required.

Do...

- Use the amount of force required to complete your mission and counter hostile acts or hostile intent
- Fight those combatants who are declared hostile. Combatants are all persons participating in military operations or activities or that pose an immediate threat to you, your unit, or other friendly forces
- **Pull the trigger when required... many people are counting on you!**

Do Not...

- Harm enemy personnel who surrender
- Kill or torture enemy prisoners of war
- Attack noncombatants who include civilians, sick and wounded, medical personnel, Enemy Prisoners of War (EPW), and chaplains
- Attack diplomatic, religious, and medical facilities or equipment
- Attack persons, vehicles, or buildings marked with a Red Cross, Red Crescent, Red Star of David, or other protected symbols
- Misuse a protected symbol



Do not attack medical facilities.



Treat EPWs humanely.

Always...

- Collect and care for all wounded
- Treat civilians and EPWs humanely and with respect
- Respect private property and possessions
- Report actual or suspected LOAC violations to your commander, staff judge advocate, and/or OSI



Handling News Media

Ref AFI 35-101, Joint Pub 3-61, AFDD 2-5.4, AFI 71-101, Vol 1

Role of the Media

Access to information is critical for a healthy democratic system. The role the media plays in this process is far too important to ignore. Senior AF leaders recognize the need for public trust and support in all facets of military operations. The military is accountable and responsible to the public for performing its national defense mission. The news media are the principal means of communicating information about the military to the general public. Remember:

Public opinion of a military operation is fragile.

Media reports can shape public opinion.

News stories shape the public agenda on issues.

Media Embeds

- The DoD embedded nearly 500 journalists during Operation IRAQI FREEDOM

- Media provided a vital role in reporting the war in Iraq and helped distinguish between Iraqi misinformation and what was actually happening
- Media embeds have become a routine part of military operations



Refer foreign news media to Public Affairs.

Contact with Foreign Nationals and Foreign Media

If you should ever have contact with any host nation local or third country national and they attempt to gather information about military operations or an organizational unit, immediately report the incident to the AFOSI. If a local AFOSI detachment isn't available, report the

incident up through your chain of command. If you're contacted by foreign news media, refer them to your public affairs representative.

Public Affairs (PA) Role

- Inform people on USAF capabilities and current issues
- PA professionals will most likely deploy with or precede your unit and help you prepare for an interview that reflects your professionalism, knowledge, and enthusiasm

Member's Role

- Learn to be proactive with the press, don't fear or avoid them, and don't perceive them as an obstacle
- Contact PA if you don't feel comfortable answering media questions
- Never forget operations security (OPSEC) guidelines and the need to protect classified information



Be proactive with the press.

The Interviewer and Audience

- Learn as much as you can about your interviewer and the intended audience
- Tailor your message accordingly

The Record—always consider yourself “on the record.” Never say anything you wouldn’t want printed or broadcasted.

Language—speak the public’s language. Avoid acronyms, jargon, or technical terms.

Arguments—never become a passive participant, and never argue with a reporter. Stay calm and stick to your talking points and your message.

Protect the Record

- Be sure to protect and, if necessary, correct the record
- Avoid repeating any false data or negative statements

Honesty—always answer honestly.

- Don’t use the cliché “no comment”
- If you don’t know the answer to a question, tell them
- If the answer is classified, say so



Don't use the cliché “no comment.”

Before you meet with a reporter, evaluate and plan each aspect of your media encounter with your public affairs advisor.

- Who will interview you, and is this interviewer a military correspondent or local reporter?
- Who’s the audience?
- Will other guests be present?
- What’s the subject?
- What are you expected to address?
- What else on this issue is in the news?
- When is the interview?
- When should you arrive?
- When will it be published or aired?
- Where will the interview take place?
- Where should you sit?
- Where should you look?
- Why do they want you?
- Why are they interested in the subject?
- How will the interview be conducted?
- How long will it last and is it live or taped?



OCONUS Legal Concerns

Ref Uniform Code of Military Justice

Be a good US ambassador while serving in foreign countries. Learn pertinent host country laws and customs to avoid potential trouble and misunderstanding.

The **Uniform Code of Military Justice (UCMJ)**—applies **wherever** US military members are serving.

Government regulations and US laws—apply no matter where you may be stationed. Some of these include LOAC, fiscal and tax laws, and various criminal laws.

Learn host country laws and customs.

Status of Forces Agreement (SOFA)—are negotiated between the US government and foreign governments regarding US military forces present in the foreign country.

Host Nation Laws

- Apply for local matters
- May be very different from US laws and customs
- Include tax and criminal laws
- May still apply to US military members even when a SOFA exists

Consult your legal representative for information concerning SOFA



The UCMJ applies wherever you serve.

Force Protection Condition (FPCON)

Ref AFI 10-245

FPCONs describe progressive levels of terrorist threats and initiates pre-planned defensive or mitigation actions. FPCON declarations are normally provided through your chain-of-command, public address system, and other available resources.



Base alert warning system.

Condition	Application	Considerations
FPCON NORMAL	Applies when a general global threat of possible terrorist activity exists.	Warrants a routine security posture.
FPCON ALPHA	Applies when there is an increased general threat of possible terrorist activity against personnel or facilities, the nature, and extent of which are unpredictable.	ALPHA measures must be capable of being maintained indefinitely.
FPCON BRAVO	Applies when an increased or more predictable threat of terrorist activity exists.	Sustaining BRAVO measures for a prolonged period may affect operational capability and relations with local authorities.
FPCON CHARLIE	Applies when an incident occurs or intelligence is received indicating some form of terrorist action or targeting against personnel or facilities is likely.	Implementation of CHARLIE measures will create hardship and affect the activities of the unit and its personnel.
FPCON DELTA	Applies in the immediate area where a terrorist attack has occurred or when intelligence has been received that terrorist action against a specific location or person is imminent.	Normally, this FPCON is declared as a localized condition. FPCON DELTA measures are not intended to be sustained for substantial periods.

Attack Warning Signals for Nuclear, Biological Chemical, and Conventional Medium and High Threat Areas

Ref AFI 10-2501, AFMAN 10-2602, Conus AFVA 10-2510, AFVA 10-2511

Standardized attack warning signals are used to posture airbases for attacks, warn of attacks in progress, initiate post-attack recovery actions, and return the airbases to a wartime state of readiness. Although warning signals are primarily designed to provide air, missile, artillery, and ground attack warning, they may also be used to warn you if a covert attack with a chemical or biological weapon is discovered. Alarm warning signal variations might be used in some geographic regions. If they are, you'll be notified what those variations are before you depart your home station or when you arrive in that region. For example, Alarm Blue is used instead of Alarm Red in South Korea. Alarm Blue will be announced and blue flags will be displayed.

USAF STANDARDIZED ATTACK WARNING SIGNALS FOR NBCC MEDIUM AND HIGH THREAT AREAS

ALARM CONDITION	IF YOU	THIS INDICATES	GENERAL ACTIONS
GREEN	HEAR: ALARM GREEN SEE: GREEN FLAG	ATTACK IS NOT PROBABLE	<ul style="list-style-type: none"> ■ MOPP 0 or directed ^{1,3} ■ Normal wartime condition ■ Resume operations ■ Continue recovery action
YELLOW	HEAR: ALARM YELLOW SEE: YELLOW FLAG	ATTACK IS PROBABLE IN LESS THAN 30 MINUTES	<ul style="list-style-type: none"> ■ MOPP 2 or directed ¹ ■ Protect and cover assets ■ Go to protective shelter or seek best protection with overhead cover ²
RED	HEAR: ALARM RED, SIREN (WAVERING TONE) SEE: RED FLAG	ATTACK BY AIR OR MISSILE IS IMMINENT OR IN PROGRESS	<ul style="list-style-type: none"> ■ Seek immediate protection with overhead cover ■ MOPP 4 or as directed ¹ ■ Report observed attacks
	HEAR: GROUND ATTACK, BUGLE (CALL-TO-ARMS) SEE: RED FLAG	ATTACK BY GROUND FORCES IS IMMINENT OR IN PROGRESS	<ul style="list-style-type: none"> ■ Take immediate cover ^{2,3} ■ MOPP 4 or as directed ■ Defend self and position ■ Report activity
BLACK	HEAR: ALARM BLACK, SIREN (STEADY TONE) SEE: BLACK FLAG	ATTACK IS OVER AND NBC CONTAMINATION AND/OR UXO HAZARDS ARE SUSPECTED OR PRESENT	<ul style="list-style-type: none"> ■ MOPP 4 or as directed ^{1,3} ■ Perform self-aid/buddy care ■ Remain under overhead cover or within shelter until otherwise directed

NOTES: **1.** Wear field gear and personal body armor (if issued) when outdoors or when directed. **2.** Commanders may direct mission-essential tasks or functions to continue at increased risk. **3.** This alarm condition may be applied to an entire installation or assigned to one or more defense sectors or zones.

Individual Protective Equipment (IPE)

IPE is the minimum personal clothing and equipment needed to protect wearers from most Nuclear, Biological, Chemical, and Conventional hazards. Use buddy assistance for donning and doffing when available.

Overgarment (OG)

- Battle dress overgarment (BDO)
- Chemical protective overgarment (CPO)/ Joint Service Lightweight Integrated Suit Technology (JSLIST, now referred to as CPO)
- Joint Firefighter Integrated Response Ensemble (JFIRE)

- IPE for ground operations (overgarment, field gear)



- Field gear (web belt, canteen, M1 canteen cap, helmet, load carrying equipment), body armor (if issued)

- Second skin (for MCU-2 Series or M45 mask)



- C2 series canister



- Hood (used with BDO)



- Gloves and glove inserts



- Overboots



- M8 and M9 Paper



- Decontamination kits

Battle Dress Overgarment (BDO)

Ref TO 14P3-1-141, TO 14P4-15-1

BDO Donning Procedures

To provide maximum protection, all closures should be as tight fitting as practical. The following donning order is provided as a guide.

BDO Trousers

- Inspect
- Loosen fasteners on leg and fly
- Don trousers
- Fasten fly snap and zipper
- Adjust side pull straps to provide snug fit around waist or use suspender loops and tie-up the trousers
- Secure leg of pants around boot



Don trousers.



Secure legs.

- Two-piece permeable water-repellent suit worn together as an overgarment (OG)
- Outer nylon/cotton twill shell layer is water repellent
- Inner layer is charcoal-impregnated
- Protective qualities lost when washed
- Mark day, month, year OG is removed from factory bag with permanent marker
- BDO is authorized for three days wear time once removed from factory bag and donned
- A contaminated BDO must be exchanged within 24 hours

BDO Coat

- Inspect
- Don coat, secure front zipper, snaps, and sleeve as applicable
- Secure coat rear snaps to trousers
- Draw up waist cord tight and tie in a bow

WARNING: Women will remove hair fasteners (hair clips, pins) and let hair hang freely before donning mask. When wearing overgarment, hair will be neatly tucked inside jacket. Failure to do so could result in an improper mask fit resulting in illness or death.

Secure coat.



SEE
Page 214,
Quick
Reference,
BDO/CPO
Checklist



BVO.



BDO.

Green Vinyl Overboot (GVO)
Black Vinyl Overboot (BVO)
Multipurpose Lightweight Overboot (MULO)

Worn over combat/field boots, fully fastened, with the upper portion worn underneath the BDO trouser

Gloves

- Inspect
- Don inserts and protective gloves
- Don glove inserts with gauntlet under duty uniform sleeves
- Don protective gloves with gauntlet over duty uniform sleeves, but beneath OG sleeves



Glove tops inside sleeves.

**Additional Items
for Completing BDO
Donning**

- Field gear
- M9 Paper (tape)
- Identification marking

BDO Doffing Procedures

Dooffing BDO in an uncontaminated environment is the reverse order of the donning procedures. After contamination, doff BDO in a Contamination Control Area (CCA). See pages 200 and 201 for CCA and Aircrew CCA layouts.

Use buddy checks when possible

Chemical Protective Overgarment (CPO)

Ref TO 14P3-1-141

- Two-piece permeable material garment (coat and trousers) with an integral hood that is compatible with MCU-2 Series and M45 protective masks.
- Coat and trousers packaging includes resealable bags
- Store resealable bags in trouser pocket and retain for reuse
- Wash/wear life for **training purposes**, unlimited for CPO
- Do not attempt to wash contaminated suits
- Do not starch, bleach, dry clean, or steam press any items
- Do not attempt stain removal on mission-ready items as it may result in damage to clothing

Use buddy checks when possible

CPO Labels

Coats and trousers have labels to record when they're removed from the factory bags and the number of times they're washed.

Preparation for a new garment

- Remove coat and trousers from factory vacuum-sealed bags
- Perform preventive maintenance checks
- Mark label with date that garment was removed from package

CPO Wash/Wear Life

CPO has 120-day service life once removed from factory sealed bag. The wash/wear life for an uncontaminated CPO is six launderings or 45 days (whichever occurs first.) With a permanent marker, mark the "laundry label" after each wash.

X 2 3 4 5 6



Preparation for a used garment

- Remove CPO from resealable bags
- Check wear date marked on label
- Perform preventive maintenance checks

Replace CPO

Change the CPO within 24 hours after contact with chemical agents.

SEE
Page 214,
Quick
Reference,
BDO/CPO
Checklist



Don trousers.



Secure closures.



Adjust waistband.

CPO Donning Procedures

To provide maximum protection, all closures should be as tight fitting as practical. The following donning order is provided as a guide.

CPO Trousers

Don the trousers by placing the legs into the trousers and pulling them up. Then:

- Close the slide fastener (front zipper) and fasten the two fly opening snaps
- Pull the suspenders over the shoulders and fasten the snap couplers (plastic clips)
- Adjust the suspenders for the proper inseam and leg length
- Adjust the waistband hook-and-pile fastener tapes for a snug fit



Adjust suspenders.



Secure legs.

Multipurpose Lightweight Overboot (MULO)

Don MULO's over the combat boots and adjust and secure the strap-and-buckle fasteners. Pull the trouser legs over the MULO's and secure the two hook-and-pile fastener tapes on each ankle so that they fit snugly around the boot. If the MULO is not available, use the black vinyl overboot (BVO.)



Secure closures.



Retention cord.



Webbing strip.



Waist drawcord.

CPO Coat

Don the coat by placing the arms into the sleeves and pulling on the coat. Then:

- Close the slide fastener (zipper) and the front closure flap up as far as the chest
- Pull the bottom of the coat down over the trousers and adjust the waist for a snug fit using the waist drawcord
- Secure the coat-retention loop. Bend over, reach between your legs and grasp the loop on the back of the garment coat. Pull on the loop so that the bottom of the garment coat fits snugly over garment trousers. Bring the loop forward between your legs. Place the loop over the webbing strip at the bottom of the coat

NOTE: Secure the coat's retention-cord loop in the manner previously described when directed to immediately assume MOPP Level 4. When directed to perform MOPP Level 1 or 2, pull the coat's waist cord through the front of the coat and tie it in a bow

- Fasten the snap on the webbing strip to keep the coat's retention-cord loop in place. Re-tie the coat's retention-cord, if needed. This may result in some discomfort in the crotch area

Additional items for completing CPO donning:

- Field gear
- M9 Paper (tape)
- Identification marking

CPO Doffing Procedures

Doffing CPO in an uncontaminated environment is the reverse order of the donning procedures. After contamination, doff CPO in a CCA.

Mission Oriented Protective Posture (MOPP)

Ref AFI 10-2501, AFMAN 10-2602, AFVA 10-2512, TO 14P3-1-141, TO 14P3-1-181

MOPP, like standardized attack warning signals, quickly increases or decreases personal protection against nuclear, biological, chemical, and conventional threats. The senior commander controls MOPP levels for the airbase.

Subordinate commanders may, however, be granted authority to reduce MOPP levels or employ MOPP options for people under their control. Field gear (A-Bag) includes helmet, web belt, canteen, and body armor (if issued.) IPE includes chemical defense ensemble (C-Bag and D-bag) and field gear.

MOPP Level 0

Available for immediate donning

- Individual protective equipment (IPE)

Carried

- Protective mask with C2 series canister or filter elements and hood installed
- Field gear worn when directed
- Aircrew—protective mask/hood with C2 series canister

Primary use

- Pre-Attack
- During periods of increased alert when the enemy has a nuclear, biological, or chemical (NBC) offensive capability
- There is no indication of NBC use in the immediate future

Marking

Print **USAF, rank, first and last name** with a permanent marker on duct tape. Attach tape to:

- **helmet** (front and rear)
- **protective hood** (horizontally above the eyelens in the front and in the approximate middle of the back of the hood)
- **jacket** (over wearer's right breast)

NOTE: Other US Services have an additional MOPP Level called MOPP READY. The USAF has no equivalent, but USAF personnel will assume MOPP Level 0 if MOPP READY is declared during joint operations.



Groundcrew

Aircrew

MOPP Level 1

Worn

- Overgarment and field gear

Carried

- Overboots, protective mask and gloves
- Aircrew—overboots, protective mask/hood, and gloves

Primary use

- Pre-Attack
- During periods of increased alert when an NBC attack could occur with little or no warning
- When NBC contamination is present or suspected and higher levels of protection are not required

Aircrew



BDO



CPO



JFIRE

MOPP Level 2

Worn

- Overgarment, overboots and field gear

Carried

- Protective mask and gloves
- Aircrew—protective mask/hood, and gloves

Primary use

- Pre-Attack or Post-Attack
- During periods of increased alert when an NBC attack could occur with little or no warning
- When NBC contamination is present or suspected and higher levels of protection are not required



Aircrew



BDO



CPO



JFIRE

MOPP Level 3**Worn**

- Overgarment, protective mask, hood, overboots, and field gear
- Aircrew—overgarment, protective mask/hood

Carried

- Gloves
- Aircrew—overboots, gloves, and field gear

Primary use

- Pre-Attack or Post-Attack
- During periods of increased alert when an NBC attack could occur with little or no warning
- When NBC contamination is present or suspected and higher levels of protection are not required

**JFIRE:
no MOPP
Level 3.**

Fire protection personnel follow UCC instructions on MOPP Level.

**Aircrew****BDO****CPO**

MOPP Level 4

Worn

- Overgarment, protective mask, hood, gloves, overboots, and field gear
- Aircrew—overgarment, mask/hood, gloves, overboots, overcape (new)

Carried

- Aircrew—field gear

Primary use

- Post-Attack
- When an NBC attack is imminent or in progress
- When NBC contamination is present or suspected or the highest level of protection is required

Aircrew



BDO



CPO



JFIRE

Additional Information For All MOPP Levels

- IPE includes the groundcrew/aircrew chemical ensemble and field gear. Carry M8 and M9 Paper, the M291 and M295 decontamination kits, and nerve agent antidotes in MOPPs 1-4. Refer to AFI 10-2501, *Full Spectrum Threat Response Planning and Operations* for IPE components and basis of issue
- Depending on the threat and mission, MOPP levels may vary within different areas of the airbase and operating location
- Refer to AFMAN 10-2602, *Nuclear Biological, Chemical and Conventional (NBCC) Defense Operations and Standards*, for options to the MOPP levels and tactics, techniques and procedures to optimize the use of MOPP levels and alarm conditions.
- Wear field gear and personal body armor (if issued) when outdoors or when directed
- Specialized clothing, such as rain and cold weather gear, is worn as the outside layer of clothing over groundcrew chemical ensemble

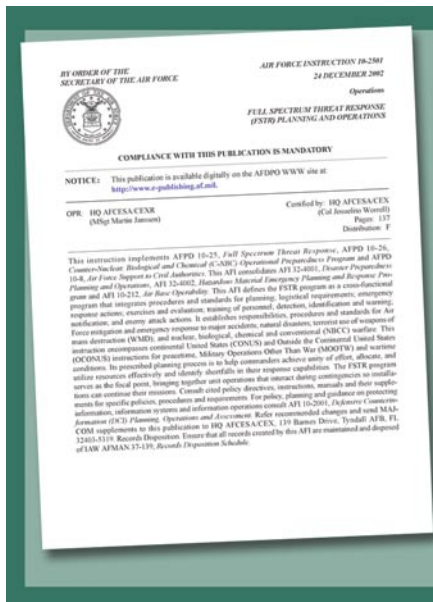

SUMMARY OF REVISIONS

This inserts change (IC2011-1) updates guidance on estimating chemical warfare agent hazard duration, provides the web site location for the HQ AFCSA-approved Chemical Warfare Agent Hazard Duration Charts, and provides guidelines for use of the 10-foot rule in chemical warfare environments.

Change	Description	Date
1.1	Introduction	8
1.2	Doctrine, Policy, and Guidance	8
1.3	Mission	7



Mask only option.

MOPP Options

Ref AFMAN 10-2602

To accomplish some missions, the senior commander may need to authorize certain MOPP options to reduce the heat burden on those affected people. MOPP options might similarly be authorized when threats do not require full body protection. The commander has three MOPP options:

Mask-Only Option—wear your protective mask only without the hood. Wear your battle dress uniform or flight suit with sleeves rolled down. Use the mask-only option after post-attack reconnaissance is complete. If an attack warning is announced and you're wearing the mask-only option, assume the directed MOPP level.

No Battle Dress Uniform or Flight Suit Option—do not wear your BDU or flight suit under your overgarment. However, do not use this option if you're reusing previously contaminated IPE.

Ventilation Option—you may open your overgarment jacket to increase ventilation and reduce thermal build-up. This option is automatically revoked with each MOPP level increase, unless specifically reauthorized by the commander.



Ventilation option.



Split-MOPP Concept

Ref AFMAN 10-2602

This tactic divides the airbase into multiple sectors or control zones and assigns threat-based protective actions and MOPP for each area that's independent from one another. It provides commanders with the flexibility to respond to threats in specific areas and continue operations within areas unaffected by the incident or at lower risk from the threat.

Your Unit Control Center (UCC) controls your movement between one sector and another. Ensure you understand what alarm condition and MOPP level applies before entering a sector or zone.

Example of how a base can be divided into zones (A-F).

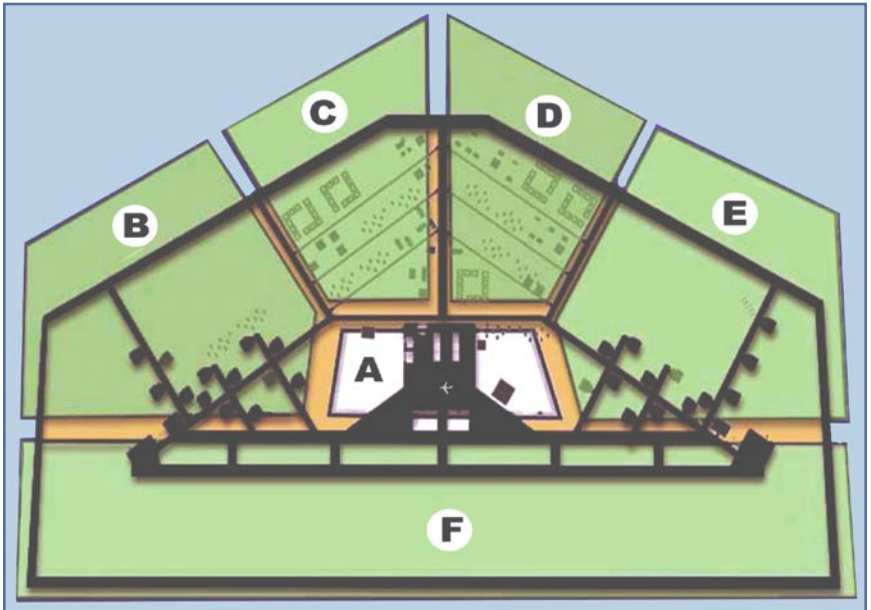

Split-MOPP

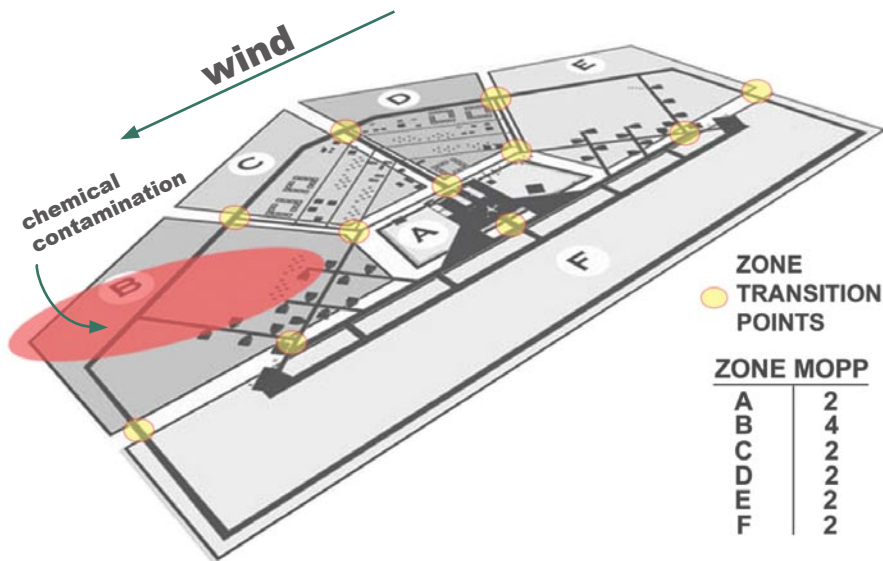

**Follow UCC instructions for movement between zones.
Call UCC before leaving or entering zones.**

Zone transition point signs include:

- Zone designator
- Zone MOPP Level
- Time/date posted
- Individual actions

Zone transition point supplies often include:

- M8 and M9 Paper
- Potable water
- Decon kits
- Glove and boot decon troughs

Before entering a dirty zone:

- Assume required MOPP
- Have full canteen
- Have M8 Paper
- Have decon kits

Before returning into a clean zone:

- Get UCC authorization
- Check self/assets for contamination
- Operationally decon self/assets
- Mark contaminated assets

Lifting and Carrying Safety

Ref AFH 36-2218, Vol 1, Vol 2

Before you begin, remove all jewelry, wear work gloves, steel-toed boots, and use proper lifting and handling techniques. Use two or more people to lift heavy and bulky objects and use a forklift to position very heavy items.

Team Lifting

- Check the object for slivers, sharp edges, and rough or slippery surfaces
- Keep fingers away from pinch and shear points
- Don't carry a load that obstructs the view of where you're going
- Clear your travel path
- Make whole body turns and crouch down to lower the object—don't turn at the waist to change direction or to put an object down
- When you carry objects up or down stairways:
 - Use a helper as a guide
 - Move a couple small safe loads over one large unsafe load
 - Adjust loads for maximum visibility



Team lifting increases safety.

Lifting



Position your feet.



Crouch close to the load.



Lift materials with a full palm grip.



Keep back as straight as possible... start movement.

Section 3

Employment

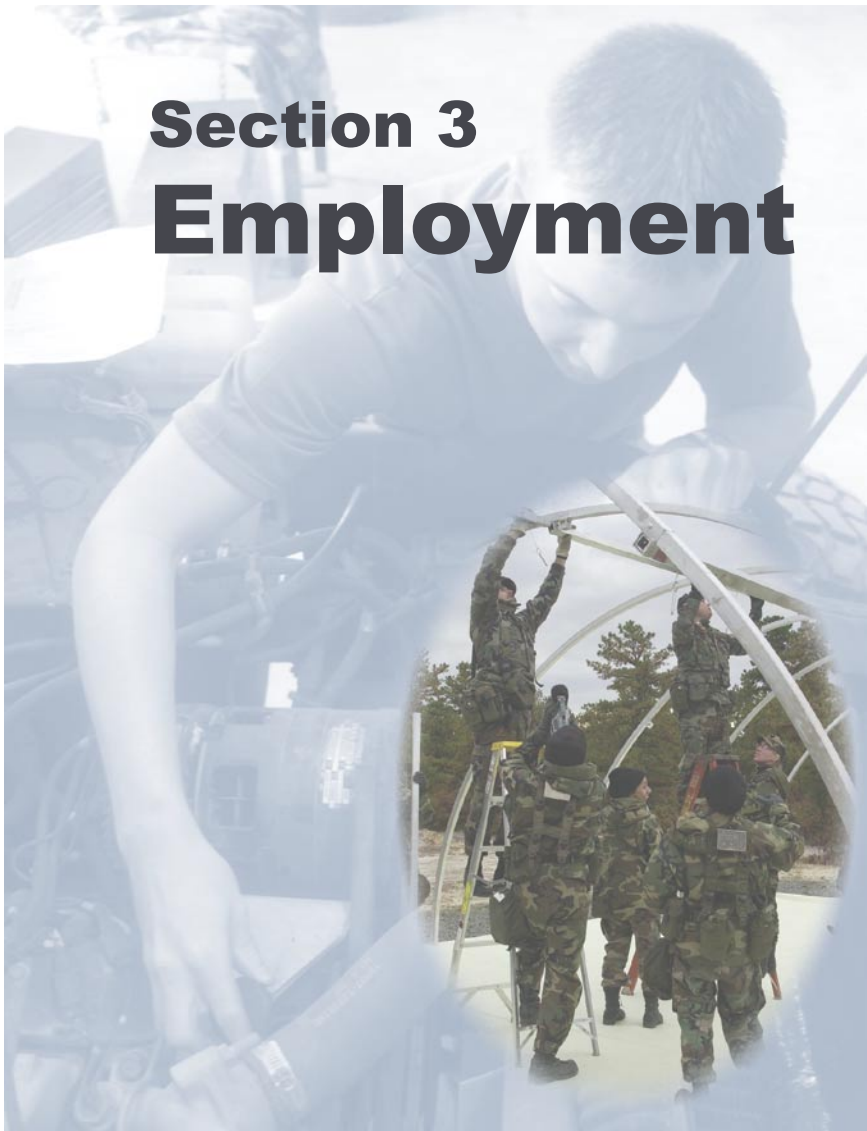



Arrival at Deployment Location

Arrival actions include in-processing, status briefings, and palletized mobility bag retrieval. If you're first to arrive at a bare base, status briefings may be delayed until initial beddown actions are complete. Review functional checklists that pertain to your particular specialty.

Briefings—generally include local alarm signals and warning systems, FPCON, MOPP, sector or zone operations, Contamination Control Area locations, shelters and bunkers, local phone numbers, billeting and feeding, EOD, EOR, fire safety, intelligence, rules of engagement, health threats/medical, and unique local information.

Base Operating Support—varies with deployment strength and mission. A main operating base support will have a full range of services. Support will be limited—especially during the early days after arrival.

Personnel Support—will be available at most deployed locations.

Finance—service is sometimes limited to cashing checks and answering pay inquiries—may not be able to process military pay changes. Complete financial affairs actions before you deploy!

Chaplain Service—responsible for religious activities, worship services, pastoral counseling, work area visitation, and pastoral and religious rites. Chaplains and chaplain assistants form Religious Support Teams (RSTs) and they normally deploy with you.



Chaplains provide a wide range of services.

Medical and Dental Support—Varies with deployment strength and mission. Support ranges from self-aid/buddy care and preventative medicine to treatment of minor medical and surgical problems (colds, diarrhea, and cuts) to fully-equipped expeditionary hospitals.

Legal Services—if available, contact the judge advocate (JA) representative for claims. If claims cannot be processed, keep receipts, photos, statements, etc., to substantiate loss. File all claims upon return to home station. You have two years from date of loss to file military claims.

Legal Defense—Defense services are available if you become the subject of a criminal investigation or other disciplinary action. Contact the ADC directly or, if not available, through the judge advocate, first sergeant, or commander.



Laundry support.



Food service.

Services—provides food, water, billeting, recreation and fitness, field laundry, mortuary affairs, and field exchanges.

Supply—provides IPE bulk storage and replaces exhausted supplies to individuals, teams, and contamination control area operators through the consolidated mobility bag control center.

Communications—services will vary. Expect minimal services during early weeks of deployment (especially at bare base) and improved services and evolving communications support throughout build-up.

Communication services will vary.



Arrival Actions

Use this list as a reminder of what to do upon arrival—your arrival briefing may satisfy many of these items.

- Determine FPCON, Attack Warning Signals, Alarm Condition, MOPP, sector/zone layout
- Recover pallet directed mobility bags (if not hand-carried) and inspect contents
- Be alert for and report suspicious individuals/activities to AFOSI or Security Forces
- When Directed
 - Retrieve operational overgarment from vapor bag
 - Place identification tape on IPE
 - Mark tape on IPE with personal information
 - Place M9 Paper (Tape) on overgarment (see page 28)
 - Place operational C2 canister on mask
 - Place second skin and hood (as applicable) on mask
 - Wear field gear and personal body armor (if issued)
 - Remove contact lenses (if worn) wear protective mask spectacles
 - Keep nerve agent antidotes at hand (when issued)
- Hydration
 - Sanitize your canteen and mask drinking tube with 0.5% bleach solution (1 part 5% bleach to 10 parts water.)
 - Fill canteen with approved drinking water and keep it full
 - Ensure M1 canteen cap is functional with protective tab attached
 - Store personal bottled water at work area and billeting quarters
- Review local threats (including criminal) and attack reporting procedures
- Review unexploded ordnance (UXO) hazard charts, marking procedures, location(s) of mined areas
- Review fire safety, alarms, alarm locations, reporting, evacuation



Annotate canister information.



Prepare IPE for use.

SEE
Page 216,
Quick
Reference,
Fluid
Replacement
Guidelines



Keep canteen full.

- Review smoking area rules
- Review tent heater operation
- Review medical warnings, advisories, sick call and casualty collection procedures
- Annotate local contact information and locations:

- Personal weapon(s) and ammunition
- Shelter, bunker, nearest evacuation area(s)
- Unit control center (UCC)
- Unit first-aid kits
- Unit firefighting equipment
- Casualty collection point(s)
- Unit and base resupply point
- Survival Recovery Center (SRC)
- Fire reporting alarm/phone number
- Medical treatment facility
- Contamination control area(s) (CCA)
- Contaminated waste disposal point
- AFOSI
- Security Forces
- Sector/zone transition points

- US services and coalition forces (familiarize yourself with their uniforms)

- Attend spin-up or NBCC defense familiarization training as directed.

- NBCC task qualification training
- Post-attack reconnaissance
- UCC, SRC, CCA operations
- Shelter or collective protection
- Contamination control
- Contamination avoidance and control measures
- Nerve agent antidotes
- Hardening and dispersal
- SABC
- Driver training (flightline, blackout)
- Combat skills

- Inspect and conduct preventive maintenance checks and services on protective mask—carry a copy of mask fit and mask assessment and fill out DD Form 1574 documentation in mask carrier

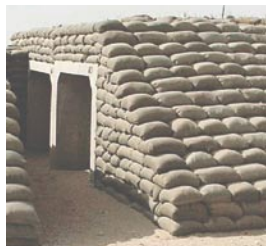

Know where bunkers are.



Follow MOPP Levels.

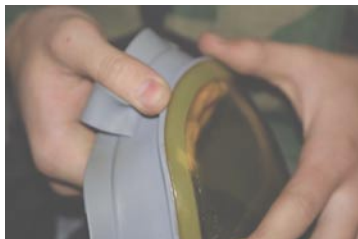

Conduct preventive maintenance checks.

The Improvised Explosive Device (IED) Threat

Ref TO 60A-1-1-22, 60A-1-1-4, AFI 91-201

Terrorist attacks are a threat at home just as they are abroad and the terrorist weapon of choice is the homemade bomb or IED. During contingencies the threat is normally greater. In recent operations, IEDs have been used against US forces with deadly effect. As the

name implies, these are homemade explosive items—and the design and complexity are limited only by the ingenuity of the builder. Safety is paramount with any IED. IEDs are made from whatever materials are easily obtainable and can take almost any form. IEDs might be hidden or not easily recognized.

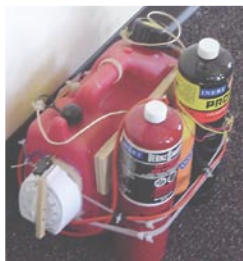

IED using gas and propane.

where you are and remain alert for all types of entrapment situations. IEDs can be planted to stir your curiosity and lure you within their lethal explosive range. There have been instances of bombers causing an explosion just to draw in the curious, the would-be rescuers and first responders—and then detonating a second device. If there is one IED, there may be more in the area.

How They Work

Time Delay or Command Detonated. An IED can function at a preset time or be detonated remotely using a hand held transmitter/receiver. Remote control devices of every sort can be used (e.g., car alarms, door bells, garage door openers, or cell phones).



The IED—in various forms—is the weapon of choice by terrorists.

You May Be A Target
Never lower your guard. Constantly maintain situational awareness—know

SEE
Page 205,
Quick
Reference,
IED
Reporting
and
Evacuation



A battery and car alarm system used as a remote control detonator.



Clock, batteries, and explosives from a time-delay IED.

Booby-Traps. An IED can also be triggered mechanically if you disturb it. This is commonly known as a “booby trap.” IEDs can be built so that any force or movement such as tugging, lifting, turning a doorknob (any normal day-to-day function) will detonate it.



Small IEDs found in a cardboard box and a soda can.

How They're Used

In the workplace, IEDs can be contained in or made to look like ordinary items—a common item such as a backpack, a discarded box, or a soda can.

In outside areas, in addition to smaller items, IEDs have been camouflaged as trashcans, cement blocks, flower containers, pieces of curbing, and crates.



Pipe bomb.



IED disguised as a backpack.



Remote control receiver hidden in plaster.

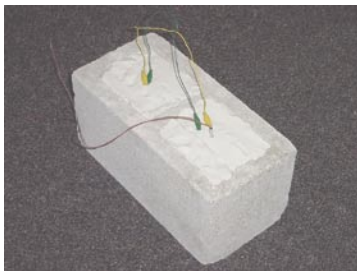

IED camouflaged as a cement block.

In a convoy ambush, IEDs can be used to disable a vehicle, followed-up with a secondary attack. If you're the target of an IED attack (in a convoy or otherwise), **DO NOT** drop your guard—stay on high alert, maintain 360° security, and be ready to defend yourself against a follow-up ambush and be observant for other IEDs designed to attack dismounted Airmen or responding forces. Know your rules of engagement—work as a team.



Hidden 155 mm projectile.



Explosive hidden beneath burlap.

Roadside IEDs can be concealed in very innovative ways. Watch for:

- Potholes covered with dirt or freshly paved areas
- Camouflaging devices such as bags along side or in the roadway
- Dead animal carcasses, or bits of a car wreck that's strewn across a highway
- An obvious IED in the open—a decoy—to slow or stop convoys

The Car-bomb

comes in all shapes and sizes from donkey carts to simple passenger cars and ambulances, to delivery trucks. An attack may even involve multiple vehicles. Possible indicators of a car bomb or "Large Vehicle IED" are:

- An auto rides low on the springs or resting low in the rear



Explosive charge in a compact car.



- Large boxes, crates, bags, or containers in plain view
- A control box, switch, or “circuitry” on the front seat/floor near the driver
- An acrid smelling smoke coming from the trunk or passenger compartment
- Curious fuel-like (diesel or kerosene) odors from the trunk or passenger compartment

The Suicide/Homicide Bomber is another form of IED threat. There is no stereotypical suicide bomber. Bulky clothing, and nervous appearance may be clues, but the best defense is vigilance in performing your duties.

Use Common Sense. If possible, make observations regarding what you think might be suspicious and use the 4Rs of UXO reporting (see page 128 and 205). Stick to your first instinct. DO NOT second-guess yourself, and do not be embarrassed to ask the experts for help.

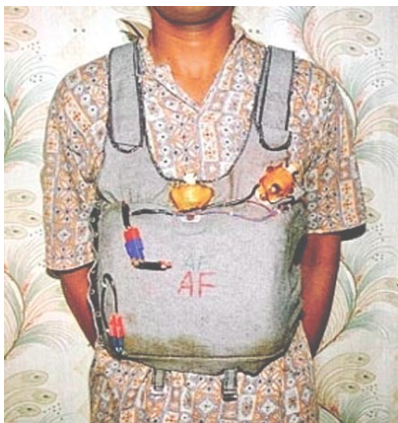

Suicide vest.



Tropical



Desert



Arctic

Health Concerns During Deployment

Many foreign countries have environments that you have to experience to fully understand. Medical threats from heat, cold, water, food, disease, poor sanitation, and pollutants are real. Remember, in the history of warfare, more people are lost to disease than to conflict.



Drink before you get thirsty.

Heat

- Heat can be incapacitating or deadly
- Drink water before you get thirsty.
Consume 1/2 quart per hour during moderate work in temperatures over 82°F
- Avoid caffeine (cola, coffee) as it increases water loss and promotes dehydration
- Follow appropriate work/rest cycles
- Your IPE increases your need to hydrate
- If urinating, that's a good sign you're hydrated

SEE
Page 216,
Quick
Reference,
**Work/Rest
Cycles**



Cold can cause injury or death.

Cold

- Cold can cause serious injury or death
- Wear the proper cold weather gear and layer your clothing for added warmth
- Limit the amount of time you must spend outdoors
- Watch for signs of frostnip, frostbite, and hypothermia
- Eat all meals to maintain energy



Drink only approved water.

Food and Water

- Local food and water can cause serious illness and may contain parasites
- DO NOT eat local foods or drink any water, including bottled water and ice, until approved by US military medical authorities.

Personal Hygiene

Diseases are a major concern. Good personal hygiene helps prevent illnesses, fights off infections, helps maintain good morale, and supports good general health. Proper field hygiene requires constant attention. To help prevent disease...

- Wash your hands frequently
- Practice good oral hygiene
- Maintain clean, dry clothing
- Change your socks daily
- Use foot powder to prevent fungal infections
- Bathe only in approved water and as often as practical
- Wash where you perspire if a shower is unavailable
- If you think you have a sexually transmitted disease, seek medical attention



Change socks daily.

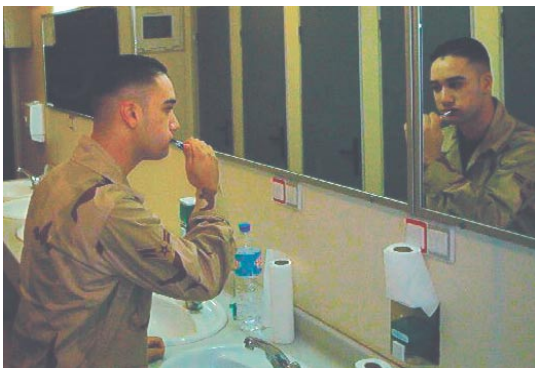

Practice good oral hygiene.

Insects

- Insects may transmit life-threatening diseases
- Use insect repellent, such as DEET on exposed skin
- Pretreat uniform with permethrin. Spray application offers protection for 6 months or 10 washes. The “kit” application offers protection for the life of the uniform unless it’s drycleaned. Read all directions before use.
- Sleep under a bed net treated with permethrin—tuck bed netting under the mattress all the way around
- DEET and permethrin re-supply can be obtained through your deployment supply channels
- Obtain anti-malarials, if required, from medical personnel and take as instructed



Use insect repellent.



Watch out for ticks and fleas.

Other Concerns

Be sure to shake out your bedroll and boots, you never know what you might find.



Scorpion



Camel spider

Animals

- Avoid contact with ALL animals—many species can transmit rabies and other diseases
- DO NOT keep local animals as pets or mascots
- If bitten or scratched by any animal, wash the wound with soap and water and seek medical attention immediately!



Avoid contact with all animals.



leech

Rivers, Lakes, Swamps, Canals

- Waterways may contain obstacles or parasites that can penetrate unprotected skin and cause serious illness
- Avoid stagnant water and open sewers—they attract mosquitoes and other disease vectors
- DO NOT swim or bathe in rivers, lakes, swamps, or canals
- If you must wade, avoid direct contact between your skin and the water if possible

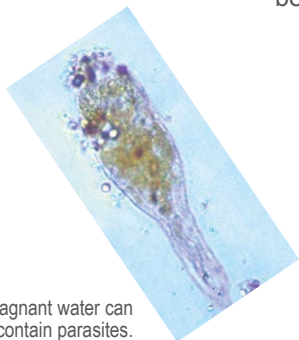

Stagnant water can contain parasites.



Asp.

Cobra.



Cottonmouth (water moccasin).



Rattlesnake.

Mental Health

Self-Maintenance

Taking care of yourself is the most effective way to manage stress. The key components to self-maintenance are basic: get sufficient sleep, eat a healthy and balanced diet, and participate in a regular exercise program. Take advantage of leisure activities during non-duty hours.



Talk with a chaplain.

It's good for you and your unit's morale—you may enjoy the experience and contribute to everyone else's well-being.

Communicate

Keep in touch with your family and friends. Reassure them that you're well and you have a good attitude about what you're doing. This will make you feel better and minimize the worry and concern that your family and friends back home have for you.

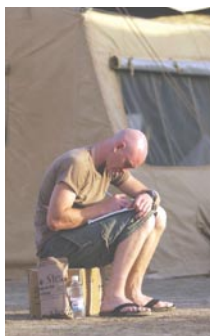

Stay in touch.

Avoid Unnecessary Stress

How you live when you're deployed directly affects your physical and mental well-being. Stress left unchecked can degrade your health and performance. If you feel

stress building, seek relief by talking to your buddies, your supervisor, a chaplain, or a medical counselor.



Participate and stay active.



Enjoy your time off.



Small Shelter System (SSS).



Deployable Shelters

Ref TO 35E5-6-1, TO 35E5-6-11

The Air Force relies on lightweight deployable shelters to meet its expeditionary warfighting role. Used primarily for lodging, recreation, medical, administration, and workcenters, they're also often used as latrines, medical facilities, and shower/shave units. These self-contained shelters incorporate electrical service for lighting and outlets. They also incorporate provisions for heating, ventilation, and air conditioning. The two most common shelters are the Alaska Small Shelter System and the Tent, Extendable, Modular, Personnel.

Alaska Small Shelter System (SSS)

The SSS is a lightweight aluminum framed structure that's covered with heavyweight vinyl fabric and is supported by an aluminum skeletal frame. When assembled, it measures approximately 20 ft x 32 ft, and covers around 650 square ft.

Tent, Extendable, Modular, Personnel (TEMPER)

The TEMPER is a modular soft-walled structure covered with a synthetic material fabric and is supported by an aluminum frame. Each module section measures 8 ft x 20 ft. However, the most common configuration combines four modules together to form a 20 ft x 32 ft unit that covers around 650 square ft.

WARNING: A tent that becomes contaminated with a liquid chemical agent may pose a toxic vapor hazard for unprotected personnel. Decontaminating the tent is practically impossible.



TEMPER tent.



Fire Safety

Ref AFPAM 10-219, AFI 32-2001, AFOSH Std 91 - 501

Unfamiliar environments, crowded accommodations, a high operations tempo (OPTEMPO) and carelessness can adversely affect fire safety. The key to fire-safe mission execution is fire prevention—make it part of your daily routine.



General Fire Prevention

- Smoke only in designated smoking areas
- Use proper receptacles for discarding smoking materials
- Practice good housekeeping in personal and storage areas
- Set up a fire alerting system
- Use carbon monoxide detectors, if available, when heating equipment may produce carbon monoxide vapors
- Test smoke detectors often
- Know fire escape plans and participate in unit fire drills
- Keep pathways to emergency exits clear



- Know your assembly location
- Know the location and operation of fire extinguishers
- Ensure fire extinguishers are operational and installed near exits and hazardous operations areas
- Only use approved undamaged electrical cords and appliances
- Clear self-help projects through Civil Engineering



Practice good housekeeping.

Fire Precautions Within Tent City

- No smoking inside any tents
- Preposition emergency water supplies and firefighting equipment
- Use only approved tent lighting and electrical kits
- Check with fire prevention specialists before you use any type of heat generating sources
- Keep combustible materials away from heat sources
- Flammable items used as tent partitions increase fire loads and fire intensity
- Ensure all tent exits are not blocked or tied shut
- Keep access roads to tents clear for fire vehicles



Only use approved lighting.



Don't overload receptacles.



Know where extinguishers are stored.





Expedient Firefighting

Ref AFMAN 10-219, AFI 32-2001

If you're faced with a fire, efficient reporting, evacuation, and quick extinguishing will significantly reduce the loss of critical resources. Become familiar with fire reporting procedures and be ready to perform expedient firefighting tasks as an auxiliary firefighter.



- P** Pull the pin
- A** Aim nozzle at base of fire
- S** Squeeze handle
- S** Sweep side-to-side

	
ordinary combustibles	flammable liquids
	
electrical equipment	combustible metals

Firefighting Agent Resources

- Dry Chemical Extinguisher: ABC rating (all fires except metals)
- Dry Powder Extinguisher: D rating (metal and metal-alloy fires)
- Halon Flightline Extinguisher: BC rating (petroleum fuels and electrical)—used for aircraft and related equipment only
- Water
- Sand



Direct firefighters to fire.

Fire Reporting

- Sound the alarm
 - Yell “FIRE, FIRE, FIRE” or as directed locally
 - Use fire alarm, triangle, air horn
 - Report all emergencies even if the fire goes out
- Notify the fire department and report
 - Name and rank
 - Location of fire
 - Nature and status of emergency
 - Status of personnel
- Evacuate the area and account for personnel, try to evacuate upwind from any fire
- Extinguish small fires (trash can size), if possible
- Direct firefighters to the fire

General Firefighting

- Fight small fires with available firefighting resources
- Always maintain an escape route
- Separate fuel sources from ignition sources
 - Shut off fuel and gas valves
 - Shut off electrical equipment
- Munitions involved in a fire are unpredictable
- Wildland fires can generate intense heat and move rapidly



Your NBC protective mask won't protect you in smoke filled environments.

Tent City Firefighting—depending on the camp layout and environmental conditions, fires can rapidly spread if your initial attempts to extinguish them fail. Timely reporting and evacuation are critical. Life, safety, and tent evacuation is a prime concern.

- Focus on preventing the spread of fire
 - Get well ahead of the fire to make a stand
 - Wet tents down
 - Cut supports and let tents collapse
- Cut the power to tent city
- Never enter a burning tent



Never enter a burning tent.

A tent can completely burn in just 2-3 minutes

Waste Control

Ref AFI 32-7080

Large amounts of solid waste can be generated during a deployment. Proper sanitation practices help to inhibit the spread of disease and it controls disease carrying vectors such as insects and rodents. Because accumulated waste provides a breeding ground for these vectors, aggressively strive to maintain a healthy living and work environment. If you're authorized to burn waste, do it in a CE approved area. Diesel fuel is preferred over gasoline to start fires because its higher flash point increases your safety when igniting.



Proper sanitation inhibits disease.



Human Waste

During a deployment, you may use bathrooms ranging from a straddle-trench to highly engineered systems. Always wash your hands after using the bathroom.

Sanitation

Depending on your deployed site population, you could see different methods of trash and garbage control that range from burning and burying techniques to full-service host

nation trash collection contracts. Don't allow trash to accumulate, and place trash in sturdy containers—preferably those with a secure cover.

Trash

Dry combustible waste may be burned on-site when landfills are nonexistent or if they're too far away for timely disposal. If you must burn, make sure the smoke won't interfere with base operations. Burn only in a fire service approved open pit or metal containers such as 55-gallon drums.



Open pit burning may be authorized.

- Food leftovers and trash in your work areas and defensive fighting positions invite rodents and insects
- Use waste collection points—minimize the chance of disease and bacteria in your areas of operation

Contaminated Waste Control and Disposal

Ref AFH 10-222V4, AFMAN 10-2602

Chemical and biological attacks can generate significant quantities of contaminated waste.

Contaminated items will include IPE and field gear, contaminated M8 and M9 Paper, M291 and M295 decon kit components, contamination avoidance covers and bulk plastics, and personal equipment. The waste that accumulates at waste disposal points, contamination control areas, and at cargo transload sites must be collected and properly disposed to limit hazards.



Properly dispose of contaminated waste.

Depending on the type and quantity of contaminated material, waste accumulation areas themselves could increase local hazards and require increased protective measures within the areas. In addition, the airbase is responsible for limiting, to the greatest extent possible, post-conflict cleanup and restoration actions. Effective actions to identify, control, and mark waste will reduce problems with waste accumulation and disposal.



Mark contaminated waste receptacles.



Unit Contaminated Waste Collection Points—establish work center, facility, and base-wide contaminated waste collection points during the pre-attack phase. Collect and dispose non-reusable contaminated items

in designated areas. Use plastic bags, trash cans, barrels, or empty munitions cans for contaminated waste storage. Trash barrels with multiple layers of plastic bags are easy to obtain and simplify waste removal. Appropriately mark contaminated waste

using NBC Marking set markers or their equivalents.

Collection points should be at least 10 feet away and downwind from facilities, bunkers, fighting positions, or Contamination Control Areas.

Clearly identify the collection point and prepare contaminated marking signs in advance to mark containers after use. Be prepared to relocate the collection point when the wind direction changes.

Units must periodically move their contaminated waste to installation contaminated waste disposal area.



Site collection points downwind from facilities.

Installation Contaminated Waste Disposal Area—the airbase consolidates contaminated waste from unit waste collection points and stores it at one or more waste disposal areas. There are three primary ways of handling large amounts of contaminated waste: open storage, burying, or burning. Open storage is the method of choice followed by burning. Bury contaminated material only as a last resort.

The airbase consolidates contaminated waste.



Food Consumption

Ref AFI 48-116

Meals Ready to Eat will be your primary food source until arrangements can be made to provide hot meals. Services will provide hot meals as soon as possible using the Single Pallet Expeditionary Kitchen and unitized group ration (UGR.)

UGRs include paper and utensil products. However, there may be times when you may still need to use your mess kit to eat. A clean mess kit helps prevent food borne illnesses. If you use the mess kit, follow the posted mess kit cleaning process. Always wash your hands before you consume food.



Services will provide hot meals ASAP.



Scrape leftover food into trash can.



Prewash in first can of soapy water.
Thoroughly wash in second can of soapy water.



Rinse in third can of clear water.



Sanitize in fourth can of sanitizing solution—submerge at least 30 seconds. Air dry before packing up.

Resources Protection and Crime Prevention

Ref AFI 31-101

Although Air Force installations overall enjoy a lower crime rate than that of other communities, crime still occurs at deployed locations. A situational awareness of what's going on and knowing how to protect resources and one's self goes a long way



Don't display large amounts of cash.

in preventing crime and maintaining mission readiness. General concerns include:

- Secure all equipment and property when unattended—particularly sensitive items such as small arms, ammunition, computers, and bulk explosives
- Avoid showing large sums of money
- Permanently mark all government property, especially highly pilferable items, and provide adequate storage for them
- Have accurate and up-to-date inventory controls and sign out highly pilferable items on an AF Form 1297/Temporary Issue Receipt
- Establish accountability procedures to control lock combinations, keys, locks, and containers
- Secure all personal property the best way possible
- Stay in groups, even on base, and don't lower your guard with people you don't know
- Promptly report confirmed incidents to Security Forces or AFOSI



Secure high value items.



Keep lockers locked.

Passive Defense

Ref: AFMAN 10-2602

Passive defense are measures you take to lessen damage from enemy attack. Most measures are typically quickly executed, inexpensive, and require minimum manpower and material.



Expedient berms protect assets.

Hardened Structure (rarely available)

- Allows occupants, systems, and support infrastructure to operate during and after attacks
- May include a collective protection system
- Typically constructed below ground level and under rock or concrete cover
- Provides substantial protection against direct attacks with chemical, biological, and conventional weapon threats
- Protects against small arms fire
- Protects against most collateral effects of nuclear weapons (blast, heat, fallout, radiation, electromagnetic pulse)



Hardened structures may include collective protection systems.

Semi-Hardened Structure

- Allows occupants, systems, and supporting infrastructure to survive attacks and continue to operate immediately following attacks
- May include a collective protection system
- Typically constructed at or below ground level
- Provides protection against the collateral effects (blast, heat, fragmentation, shock, and contamination) of attacks with chemical, biological, and conventional weapon threats
- Protects against small arms fire
- Protects against some collateral effects of nuclear weapons (blast, heat, fallout, radiation, electromagnetic pulse)



Semi-hardened bunker, without collective protection.

Splinter Protected

- Allows occupants to survive attacks and limits damage to systems, supporting infrastructure, and resources
- May include collective protection system
- Limits collateral effects (blast, heat, fragmentation, and shock) of conventional weapon attacks
- Provides limited protection against small arms fire
- Provides limited protection against collateral effects (blast, heat, fallout, radiation, electromagnetic pulse) of nuclear weapons

HESCO
concertainer
revetment
for splinter
protection.



Expedient Hardening

Ref AFPAM 10-219 Vol 2, AFMAN 10-2602

Sandbagging provides expedient hardening to protect resources from conventional weapons effects. Sandbags can be built into freestanding barriers. In Chem/Bio threat areas, to reduce the chemical contact hazard duration, use burlap bags in lieu of plastic bags (when available) as chemical agents will sorb more rapidly into burlap bags than plastic materials. Check with the base civil engineer before commencing any sandbag effort. Earth berms may be your only protection until a sandbagging plan is approved.



Sandbag Wall Construction

- Turn sandbags inside-out so stitching is not exposed
- Fill bags three-fourths full with earth or a dry soil-cement mixture
- Tuck in bottom corners after they're filled
- Place tied-off ends and side seams away from the threat
- Lay the first course as a header
- Build the wall with alternating stretchers courses
- Position sandbags so the layers have the same pitch as the base
- Stack sandbag at a slope ratio of 1:4 or 1:5
- Create L-shaped ingress/ egress points
- The top row should be placed as a header

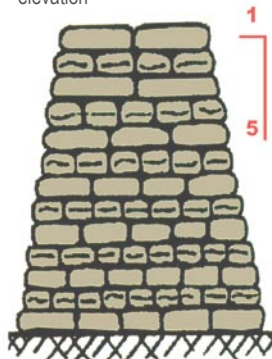
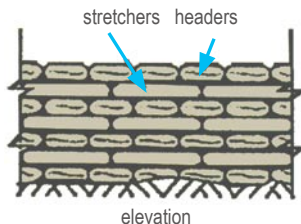

Build a side slope of 1:4 or 1:5 to prevent collapse

Camouflage, Concealment, and Blackout

Ref AFPAM 10-219, Vol 2, AFMAN 10-2602

Camouflage, concealment, and blackout primarily applies to conventional aircraft and ground force enemy attack.



Camouflage Nets—breaks up outline of covered assets. In Chem/Bio threat areas, resist using camouflage nets as much as possible. Chemical agents rapidly sorb into net surfaces and cause an extended chemical hazard. Be extremely careful around contaminated camouflage nets and wear the appropriate MOPP gear.



Don't bunch up assets.

Dispersal—spread critical assets out to maximize their survival. Take advantage of natural cover. Distribute and hide critical resources outside of the effective range of shoulder-fired weapons that enemy ground forces may possess and not along the perimeter. When possible, disperse assets in or near the work area they'll support.

Ideally, each dispersal site should have at least two entry/exit routes on concrete or asphalt (if possible, due to rapid chemical agent sorption rates on these surfaces.) Don't bunch vehicles up into one area. Disperse more than just vehicles. Also disperse equipment, tires, and other critical supplies. In medium and high NBCC threat areas, disperse with overhead cover and use reinforced facilities when available. Effective dispersal lessens the odds of contamination and damage.



Cat's eye headlights.

Blackout—a method to limit nighttime illumination of areas, facilities, and vehicles. Turning off interior and exterior lights, covering doors and windows, and creating “cat's eyes” on vehicle running lights are forms of blackout.

Limitations—except for an enemy’s real-time satellite surveillance capability, camouflage, concealment, and blackout countermeasures are ineffective against low tech Tactical Ballistic Missiles and Unmanned Aerial Vehicles, and high tech threat missile systems and global positioning system guided weapons. Camouflage, concealment, and blackout efforts, however, are valuable strategies against penetrating ground force attacks and many intelligence gathering efforts.



Airfield blackout may be necessary.

Noise—the enemy is listening—keep it down

- Practice noise discipline continuously
- Talking, coughing, sneezing, and sniffing can reveal your position—especially at night
- Bumping walls, tapping fingers, rattling paper, or shuffling your feet can also give your position away
- Noise can help identify an enemy—the noise an enemy makes can give them away

Litter—you may attract more than the enemy if you litter

- Eliminate litter—it’s a nuisance and it can reveal your presence



Keep light to a minimum.

Light Discipline—Given a chance, an enemy will watch you day and night. At night, there might be times when you’ll need flashlights or chemical light sticks to do your job. That’s ok, but don’t unnecessarily draw attention to yourself by leaving a flashlight on or exposing chemical light sticks when they’re not needed. Learn how to safely move around at night using natural light. At entry control points, don’t silhouette sentries with

lights or cause them to lose their “night vision” by shining a light directly in their eyes. It could take several minutes or longer for their eyes to readjust back to low light.

During a post-attack phase when M8 Paper is pre-positioned, only use a white light to read the paper at night. Using a flashlight with a colored lens or using chemical light sticks could cause you to miss color changes on the detector paper and make you think that chemical contamination is not present when the opposite might be true!



Read M8 Paper only with white light.



Use overhead cover to inhibit contamination.

Defensive Fighting Position (DFP)

Ref AFMAN 10-2602, AFH 10-222V14

Hasty and fighting DFPs provide all-around cover from enemy fire and allows defenders to observe and repel enemy forces. In Chem/Bio threat areas, DFPs

present dangerous environments due to the interaction between chemical agents and many materials used in DFP construction. Reduced airflow, the inability for defenders to leave a contaminated area, and the close proximity of the occupant's respiratory tract to the contaminated surface (inches instead of feet) all provide survival challenges.

DFP Construction—to inhibit falling chemical droplets from entering, build DFPs with two-foot overhangs above the observation ports unless

it interferes with weapon firing. Also, build small L-shaped entrances to inhibit contamination intrusion. If you're given the option, use unpainted concrete for DFP construction as that allows chemical agents to absorb faster than any other likely construction material. Floor construction similarly makes a difference to DFP occupants during the post attack environment, so consider chemical agent interaction with floor surfaces.

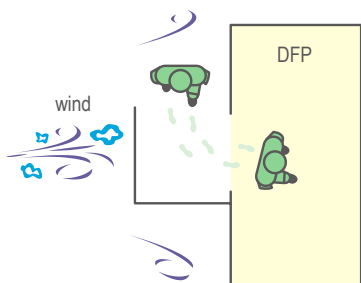

L-shaped entrances inhibit contamination.

DFP Camouflage—use exterior latex paint to create camouflage patterns. Latex lets liquid agents rapidly sorb below the surface and minimizes the contact hazard period. Unless required for tactical operations, don't use camouflage nets near DFPs since chemical hazards will exist for an extended period.



Hasty DFP.

Hasty DFPs

- Temporary—provides partial protection from enemy fire
- Select position that provides ample frontal coverage
- Should be a small depression or hole that is at least 18 inches deep

Fighting DFPs

- Construction—build for two people with unrestricted observation and enemy engagement ports
- Position to provide frontal cover to engage the enemy without exposing yourself
- Construct 6 feet long (1.8 m), 3 feet wide (0.9 m), and arm-pit deep
- Build grenade sumps one entrenching tool wide and deep at both ends
- Provide at least 18 inches (0.5 m) of dirt overhead. Use adequate amount of stringers to support the weight
- Camouflage with natural and artificial foliage to conceal occupants
- Check camouflage daily—view it from 40 yards (36 m) in front—it's good if you can't easily spot it
- Foliage that you might have utilized to camouflage your position must be changed as soon as it starts to stand out from foliage of the surrounding area



Build DFPs for two people.

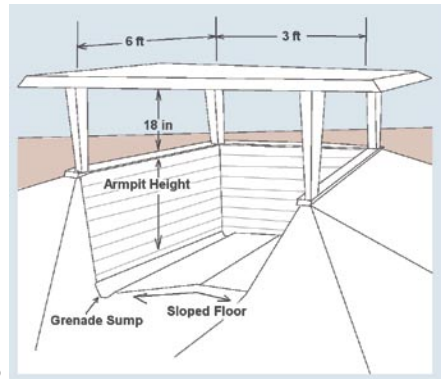

Cut-away DFP.

Contamination Avoidance and NBC Pre-Attack Preparation

Ref AFMAN 10-2602

In Chemical Warfare Threat Areas, contamination avoidance is the key to prevent assets from becoming contaminated.

Place assets beneath an overhead cover when they're not in use. If overhead cover is unavailable, wrap or cover assets with at least one layer of barrier material such as repellent plastic sheets, canvas, tarpaulins, or specialized NBC protective covers (if available.) Wind can cause havoc on contamination avoidance covers. Ensure all barrier material is tightly secured around assets stored outdoors and roll excess material beneath the asset.



Secure barrier material. Roll excess material beneath asset, away from contaminants.

Two Cover Layers—

use two cover layers when possible so the exposed cover, along with any contamination, can be easily removed, safely discarded, and replaced. Discard contaminated barrier material and M8 paper in your unit contaminated waste collection point. Periodically take accumulated trash to the installation contaminated

waste disposal area. Place M8 Paper on the exposed horizontal layer of barrier material and don't forget to mark and date its time of placement.

Protect Facilities—close all facility windows, turn off ventilation systems (or close outside air intake—Heating, Ventilation and Air Conditioning (HVAC), respirators, air compressors, etc.) at the time of attack, and implement single-entry procedures. Pre-plan specific actions when attack threats increase. Add these actions to your work center operational checklists.



Move vehicles beneath overhead cover.



Protect palletized cargo.



Cover outside assets beneath two barrier layers.



Keep doors closed.



Boot and glove decon.

Limit Contamination Spread—create, place, and use boot and glove decontamination troughs at entries to shelters, work centers, large frame aircraft doors, hatches, loading ramps, and around work areas. Fill the troughs with a 5% chlorine solution (household bleach), and replace the solution every 48 hours or after 400 people have used it (whichever comes first), or as directed.



Chemical Agent Detection—pre-position M8 Paper throughout your work area on flat horizontal surfaces that are likely to become contaminated during a chemical attack. Avoid surfaces that could reach temperatures above 125° F as the dye will deteriorate quickly. Place M8 Paper so it can be easily seen during post-attack surveys. Mark time and date on M8 Paper.



Pre-position M8 Paper on flat horizontal surfaces.

Contingency Operations—Air Mobility Command will move strategic airlift cargo regardless of the chemical or biological environment at the deployment site. Contamination avoidance is the key to air mobility movement. If you're deploying to a NBCC threat area, triple-wrap each pallet and affix M8 Paper on the outside and on each internal layer of the barrier material. The technique is to place one barrier layer below the cargo net and two over the top. If a pallet should become contaminated, discard and replace the outer layer. Contaminated pallet netting presents a residual vapor hazard, it can't be decontaminated, and must be treated as contaminated waste. When you've completed pallet build-up and protection, it should look much like this example:

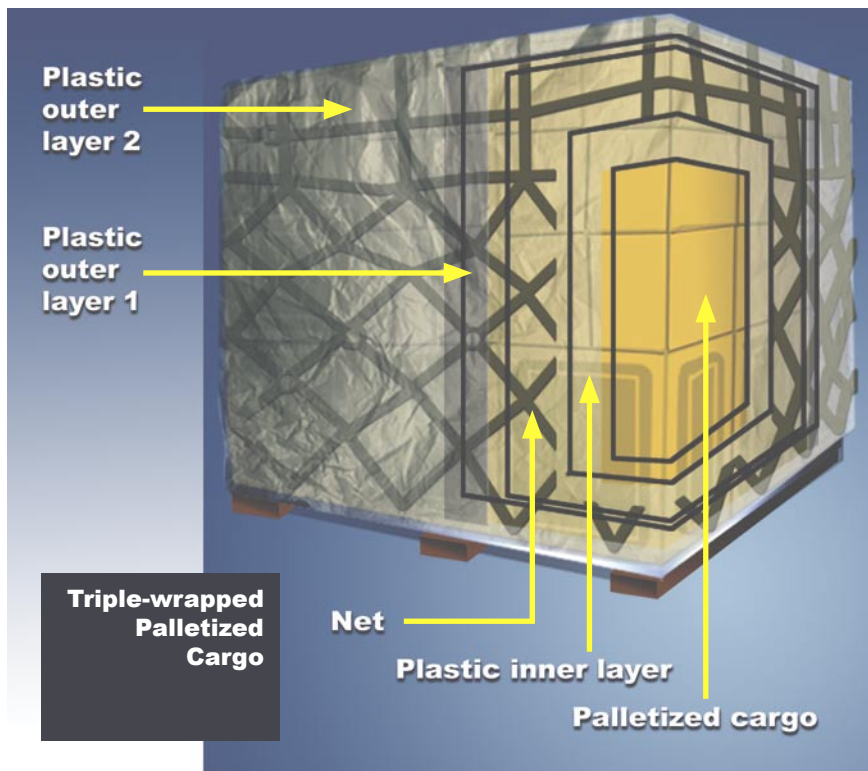



Command and Control

Ref AFMAN 10-2602

Effective command and control is essential to mission accomplishment and base survivability. You may notice some command and control differences at your deployed location compared to your home station—for example your

home base may have a wing operations center (WOC) and the deployed location may have an expeditionary operations center (EOC) but, they're the same thing. Here, we'll use the term WOC.

Wing Operations Center (WOC)—the top echelon of airbase operations led by the senior Air Force commander.

- Primary focus is flight operations, airbase security, and airbase support
- Focal point for resource allocation, mission tasking, status reporting, and decision making
- Battle staff includes senior officers from the medical, mission support, operations, and maintenance groups
- Senior officers representing major tenants or host-nation forces may be present
- Directs FPCON, MOPP, and alarm signal changes



Survival Recovery Center (SRC)—the nerve center for airbase ground operations and attack protection and recovery operations. It recommends courses of action and executes pre-planned and WOC-directed actions.

Unit Control Centers (UCC)—focal points for unit command and control functions

- Directs and monitors unit contamination control and dispersal actions
- Rapidly provides alarm condition and MOPP Level changes to unit personnel
- Directs and monitors unit pre-, trans-, and post-attack actions
- Directs unit personnel movement through base Split-MOPP sectors or zones
- Monitors unit shelter operations and works closely with shelter managers
- Collects vehicles and equipment contamination status reports, logs and upchannels information
- Remains in contact with alternate control center (if assigned)
- Tracks locations of all known contamination and unexploded ordnance that may affect unit's mission
- Warns unit personnel of hazards and directs their movements accordingly

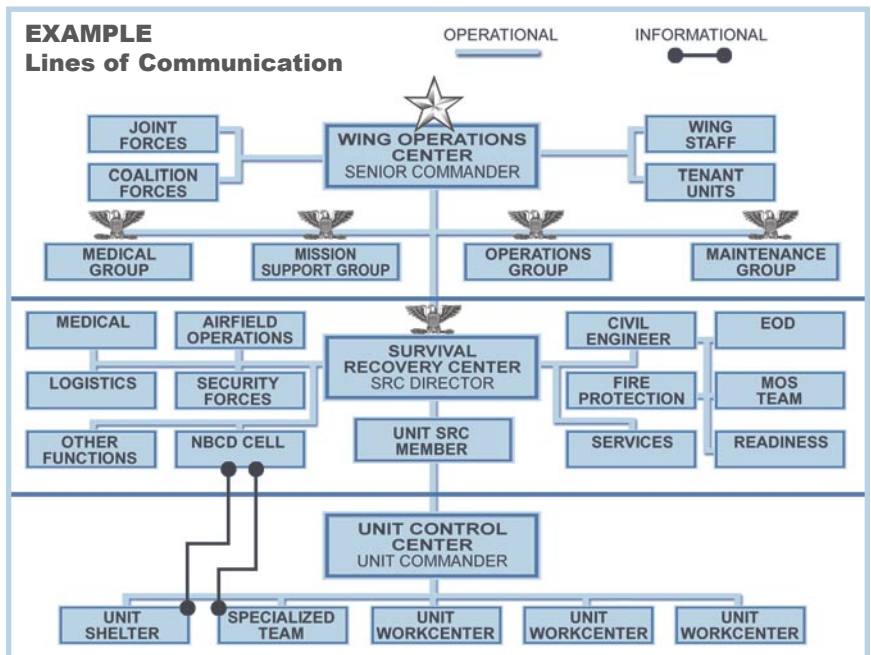

Field Communications

Ref AFI 31-302

Communication is essential to mission accomplishment. If you encounter unfamiliar equipment, your communications function will instruct you on its use.

Local area networks and email may also be available—follow the established guidelines when using these capabilities.



Communications Security (COMSEC)

- Non-secure phone, radio, and computer network systems are subject to monitoring
- Never discuss sensitive or classified information over non-secure systems
- Never talk around, paraphrase, or use code words to disguise sensitive or classified information
- Always use secure systems to discuss sensitive or classified information



Observe COMSEC.

Telephone Bomb Threats

If you receive a bomb threat over the telephone, obtain and retain as much information about the call and caller as possible. Use the AF Form 440, Bomb Threat Aid, if available or take notes during the call. Try to keep the caller on the phone as long as possible. Do not hang up the phone after the caller ends the phone call. Immediately report the incident to Security Forces and follow their instructions.



Anti-Terrorism Force Protection Measures

Ref DoD 0-2000.12H, JS Guide 5260, AFI 10-245

Terrorists don't discriminate! If you're an American, you're a potential terrorist target. Follow these key steps to lessen your threat.

Keep a Low Profile

- Your dress, conduct, and mannerisms should not attract attention
- Make an effort to blend in
- Avoid publicity, large crowds, demonstrations, and civil disturbances



Vary your routes.

Stay Unpredictable

- Vary your route, time, and mode of travel
- Vary where and when you go
- Vary your appearance
- Let others know where you're going and when you plan to return

Be Alert

- Watch for anything suspicious
- Do not release personal information
- If you believe you're being followed, go to a predetermined safe area
- Immediately report any suspicious incidents to Security Forces and AFOSI
- Carry important phone numbers, i.e. US embassy, security forces, UCC, EOD, etc.

If You Are Taken Hostage

The chances of you being taken hostage are very remote. But should it happen, remember your personal conduct can influence your treatment. If you're taken hostage there are three important rules to follow:

- Analyze the problem so as to not aggravate the situation
- Make educated decisions to keep the situation from worsening
- Maintain discipline to remain on the best terms with your captors

Be Suspicious

Ref AFMAN, 32-4022

Hate is a profound feeling that makes some people do terrible and irrational things. Because you're a US military member, there are some very dangerous people in this world who hate you and hate what you stand for. So, be suspicious, but not reckless!



Improvised explosive device.

Hostile governments and terrorists often use improvised explosive devices (IED) to destroy their targets or to generate mass hysteria. Only the imagination and the talent of the builder limit IED construction techniques—there is no standard identification chart that will tell you what the next IED will look like. Become familiar with workcenter surroundings. Keep your workcenter neat and organized so it's easy to spot anything that may seem out of place or unknown. Get to know your coworkers so you can more easily spot people who don't belong in your area. Rely upon your training and sometimes your "gut" feeling if you discover an item you suspect might be an IED. React as if you discover a UXO by following the 4R's—Recognize, Record, Retreat, and Report (see page 128.) Never risk your life by moving or opening an IED to get a better description.



Suicide bombers are a real threat as well! As with IEDs, there is no standard identification or description that will tell you who the next suicide bomber will be, what they'll look like, or how they'll act. Suicide bombers have already targeted public areas overseas where Americans and other foreigners congregate. Be security conscious and know the off-limits and areas of concern. Challenge or report unknown people around your work area. If you get a "bad feeling" about something, many times there's a reason—tell your coworkers when you think something doesn't



New surroundings can feel uneasy.

feel right. Follow your training and your “instinct” when uncomfortable situations arise.

It’s normal to have feelings of uneasiness after you arrive at your deployment location. But, don’t become consumed by fear. Slowly adjust to your new surroundings, learn all you can from more experienced people, and follow your training.

Terrorist Threats and Vehicles

Ref Force Protection Battlelab Vehicle Bomb Mitigation Guide

There are no typical vehicles associated with vehicle bombs. Terrorists are imaginative and cunning and will go to great lengths to kill you and further their cause.

With vehicles, they easily blend into their surroundings and don’t need to rely on the cover of darkness to strike. Watch for unusual and creative approaches a

terrorist might use to slip through a cordon or past a checkpoint—perhaps using an emergency response vehicle (i.e. ambulance) following an incident, to deliver a bomb. To engage this effort, a terrorist may even create the incident to lure first-responders to the scene then entrap and attack them with explosive devices. Watch for suspicious behavior or refusal to obey orders. Know your rules of engagement. If you’re one who responds to emergencies, stay on high-alert while you’re performing your duties.



Terrorists use all types of vehicles.

Vehicle Search Procedures—If you're tasked to do a vehicle search, you're not only looking for the "big bomb" but for any type of weapon, improvised explosive device, or explosives. Ask the vehicle driver to open all compartments, doors, the hood, and trunk (if applicable.) Look for things that don't belong there or things that appear out of place. For example, in a dirty engine compartment, be suspicious of shiny new wires or a box or carton you find stored behind the vehicle's grille. If you find anything suspicious, follow your local reporting procedures. Even if everything appears to be in order, you can still consider a vehicle as suspicious if the driver refuses to open any compartment (e.g. hood, trunk, passenger doors, glove box, or even a package.) If this happens, heighten your vigilance and immediately notify your supervisor or Security Forces and request help. If a previously searched vehicle has been left unattended in an unsecure environment, another vehicle search should be conducted. This also applies when receiving a rental car.



INSPECT:
under seats, glove box,
and all compartments

- Dash board
- Engine compartment
- Behind/under front and rear bumper
- Behind grill
- Wheel well and tires
- Door panels and interior
- Undercarriage
- Spare tire
- Fuel tank
- Cargo area

Pre-Attack Actions

Ref AFMAN 10-2602

Alarm Green—normal condition of readiness in wartime. Attack is not probable and there is no active threat of attack at present. However, local procedures may vary.



No active attack threat.

As Directed

- Perform pre-attack preparations
- Remove contact lenses and wear protective mask eyeglasses
- Wear field gear and personal body armor
- Inspect IPE and assume MOPP 0
- Implement contamination avoidance actions
- Implement contamination detection actions
- Protect facilities, equipment, aircraft, vehicles
 - Close windows, doors, hatches, and access panels
 - Pre-position M8 Paper throughout work areas and on exposed assets—mark time and date of placement
 - Store assets beneath overhead cover, inside shelters, within revetments, or similar structure
 - Cover exposed assets with contamination avoidance material—double wrap where practical
- Implement hardening and dispersal actions



Prepare equipment for use.



- Know immediate and operational decon actions
- Know post-attack reconnaissance (PAR) procedures
- Know Split-MOPP zone or sector operation procedures
- Know local alarm signals and actions
- Keep supervisor and UCC informed of progress
- Remain vigilant for possible threats



Prepare equipment.

Reverting Back to Pre-Attack... Alarm Green following Alarm Red or Black—NBCC hazards

(damage, UXO, and NBC contamination) may be present. However, they're not an operational risk for people in MOPP 0 outside of marked hazard areas.

- Perform pre-attack preparations, recovery actions, and stay alert for hazards
- Verify NBCC and other hazard markers remain visible day and night
- Verify UCC receipt of hazard, UXO, damage, and casualty reports

- Replace exhausted supplies and contamination avoidance material (CCA, decon, firefighting, self-aid and buddy care (SABC), water, shelter supplies)
- Replace contaminated M8 and M9 Paper (Tape)—mark time and date of placement
- Discard used decon kits and detection paper as contaminated waste
- Inform UCC of contaminated waste accumulation
- Casualty care
 - Decontaminate casualty as necessary
 - Verify zone or sector hazards along travel route
 - Return casualty's weapon and ammunition to armory
 - Keep IPE with casualty



Watch for hazards.



Continue pre-attack actions.



Alarm Yellow—attack probable in less than 30 minutes. Focus upon final protection and contamination avoidance measures to mitigate attack effects. Commanders may direct mission-essential tasks or



Listen for warnings.

functions to continue.

- Notify others within the immediate area and over communications systems
- Remain in shelter, go to shelter, or seek protection with overhead cover
- Do buddy checks to verify correct IPE wear
- Quickly and safely terminate routine or non-critical operations
- Protect and cover assets
- Park vehicles indoors or under cover
- Close doors, windows, vents, hatches, openings
- Shut off HVAC systems
- MOPP Implementation:
 - If you are currently in MOPP 0 or MOPP 1, implement MOPP 2 or as directed
 - If you are currently in MOPP 3, MOPP 4, or the MASK ONLY option, remain in that MOPP and stay masked unless otherwise directed



Shut off HVAC.



Assume MOPP as directed.



Additional Attack Preparations Under Alarm Yellow

Ref AFMAN 10-2602

A hardened aircraft shelter (HAS) provides optimum protection for aircraft, vehicles, and equipment. Use extreme caution when you drive a vehicle into a HAS that contains aircraft or equipment. Once inside, close the HAS doors. If there's no room for your vehicle inside a HAS, park near the side of the shelter, cover your vehicle with contamination avoidance material, and run inside.



Aircrews should be transported in covered vehicles. Passengers should don the appropriate MOPP while the driver heads toward the squad-operations facility for shelter. Running aircraft may be ordered to launch-to-survive or told to return to a HAS, shut down, and seal the HAS doors.



DO NOT cover refueling vehicles or liquid oxygen and liquid nitrogen equipment with plastic barrier materials. Plastic sheets can accumulate static electricity and discharge sparks at any time—particularly during removal.



With munitions handling equipment, if you must choose between protecting a bomb trailer's cargo surface or the tongue, protect the cargo surface. Also, if space exists, drive forklifts into igloos, shut them off, and close the igloo doors.



Military working dog (MWD) patrols should go to the nearest collective protection shelter or nearest protection with overhead cover. For missile attacks, put the MWD inside a vehicle, cargo aircraft, or other area that avoids agent fallout. Handlers and dogs should remain sheltered until you hear MOPP 0, 1, 2, or directed otherwise.



Services personnel should disperse food assets into fixed or hardened shelters, or refrigeration units. Cover the units with plastic and seal their openings with tape.

Section 4

Fight





Integrated Base Defense (IBD)

Ref IBD CONOPS 2020

IBD provides full dimensional protection for people and assets. It provides the framework for a fully integrated base defense that ensures our forces can pursue the defeat of any adversary or control of any situation across

the threat and conflict spectrum. Most importantly, you and every Airman play an extremely vital role as a sensor and potential defender in the Force Protection (FP) and IBD battlespace.

FP battlespace covers airbases, detached sites, transient forces and convoys. IBD battlespace begins with the flightline, protection level (PL) resources (i.e. critical USAF resources that are designated a separate level of protection), and cantonment areas. It expands out to, and beyond, the base perimeter. IBD battlespace dominance can be achieved through interacting capabilities channeled through an integrated command and control network.

Capabilities essential to IBD

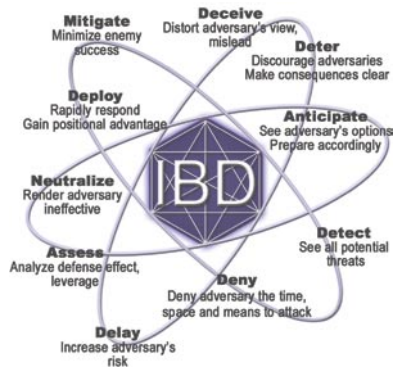

These interacting measures aid in the Air Forces' ability to See First, Understand First, and ultimately, Act First.



Gather information.

See First

- Relentless Intelligence and Information Capture—Gather, collate and disseminate effectively, information on defense related activity within and beyond the IBD battlespace

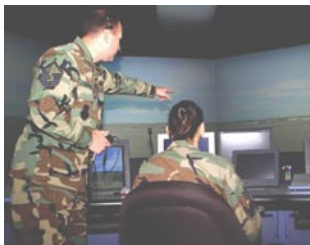

- Detect and Identify Threats—Analyze collated information and deduce likely threats. Maintain a reconnaissance, intelligence, surveillance and target acquisition capability
- Predict Threat Course of Actions (COA)—Use planning tools to process information and deductions and arrive at likely threat COAs

Understand First

- Identify Vulnerabilities—Critically assess the effectiveness of the defense that is in place. Aggressively examine the integrity of the defense, know the weaknesses that exist and plan accordingly
- Know and Manage Risks—Where the burden of a shortfall exists in the defense, ensure that it is carried unobtrusively and in a manner that minimizes the risk to assets in priority order. To minimize risk, manage any shortfall commensurate with the emerging situation and changes in defense resources

Act First

- Determine Options—Identify broad COAs open to IBD defenders to meet the perceived threat. Consider each COA against the defense mission
- Decide First—Taking into account the advantages and disadvantages of each COA, the decision must be a logical result of the analysis process. The absence of ideal conditions, such as when defense forces are undermanned, does not preclude the selection of the best COA in the prevailing circumstances



Analyze information.



Remove threat.

- Act to Remove Threat—Action to remove a threat could be the initiating of a lethal or non-lethal engagement at a time and place of the Air Force's choosing. Equally, amending the defense posture and thereby rendering ineffective an adversary's preferred line of attack, constitutes acting to remove a threat

Security Procedures

Cordons

Ref AFI 10-403, AFMAN 91-201, AFMAN 10-2602

A cordon protects people, equipment, and classified material during major incidents, and it's normally marked off with rope, tape, and appropriate signs. Where no toxic or explosive materials are involved, its size is dictated by the affected area and the area disaster response force teams need to conduct unhindered operations. Security Forces personnel may direct non-security force personnel to act as cordon sentries. If you're needed to work as a cordon sentry, strictly follow your instructions. Some situations that may warrant a cordon are:

- Discovery of unexploded ordnance
- Bomb threat/suspicious package
- Damage caused by a natural disaster
- Major accidents
- Contaminated areas following an enemy attack



A cordon protects people.



Block cordon entrances.

Cordon Sentries

- Secure their assigned posts on the cordon perimeter—prevent access to incident site
- Direct arriving people to report to the entry control point
- Report the names of anyone who evacuates the cordon at your post to the On Scene Commander (OSC)
- Do not enter the cordon area or leave your post until properly relieved

Passing Through Entry Control Points

- Control entry into installations, controlled and restricted areas, Chemical, Biological, Radiological, Nuclear, and high yield Explosives (CBRNE) incidents, and major incidents



Report evacuees to OSC.

- Entry Authority Lists are checked to gain access to controlled and restricted areas
- Be prepared to show your identification card
- You and your belongings may be searched
- Your vehicle may be searched
- Know the local MOPP entry control procedures, sign/countersign, or chem code

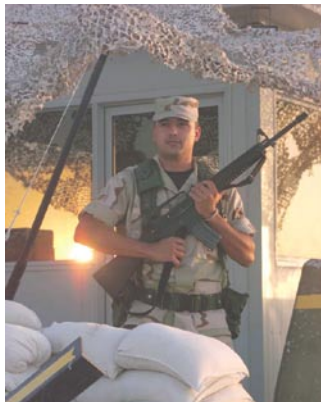

Entry control point.



Be continually vigilant.

Challenging Intruders

Ref AFMAN 31-222

Intruders can be aggressive or passive, male or female, adult or child, and can show up at any location, at any time. Be continually vigilant. Challenge all intruders. Treat all individuals or groups as hostile whether weapons are present or not. Challenge an individual, but always maintain proper cover and concealment while doing so. NOTE: Cover and concealment means

to place yourself out of harms way by concealing your location and being in a protective position in case you are fired upon. Challenges are divided into two areas: individuals or groups.

Challenge Steps

- Upon hearing or seeing a group or lone person approach, command the group or person to “**Halt**” just loud enough to be heard. Shouting the command can give away your position. Note: Learn the word “halt” in the language of the country you are currently in.



Halt!

If challenging a vehicle, DO NOT stand directly in the path of the vehicle to get it to stop—if the vehicle flees, note the direction of travel, and immediately report the incident to your UCC or Security Forces

- When the group or person stops, command, “**Who goes there?**”
- The challenged person should respond with their **Rank, Name, and Unit**
- After the person identifies him or herself, command “**Advance To Be Recognized!**” Note: If in a group, command only one person forward
- When the person comes within 10 feet, command “**Halt!**” and issue the **Challenge Word or Sign**, just loud enough to be heard without being heard by others
- If the person responds with the correct **Password or Countersign**, let the person pass. Note: If in a group, that person you called forward must then identify the members of that group as they pass
- If the person fails to stop or answer at anytime during the challenge, immediately notify your UCC and Security Forces
- Command the unidentified person or group to “**Halt!**” again
- Once they’ve stopped, command the person or group to “**Turn Away From The Sound of My Voice!**” Note: If they fail to heed your commands, follow the Rules of Engagement established for your Area of Responsibility.



Who goes there?



Advance to be recognized.



Turn away from sound of my voice and drop slowly to your knees.



- Notify your UCC and SF control center of your situation by using the S-A-L-U-T-E report (see page 95) and your location.
- Follow UCC instructions Note: If a weapon(s) is visible, instruct the person or group to place their weapon(s) on the ground and move six to eight steps forward (away from you)



Lie down on stomach.

- Command the person or group to **“Drop Slowly To Your Knees and Lie Down on Your Stomach!”**

Note: Separate each person from a group before you place them on the ground.

Remember to keep them in a position where you can observe them until help arrives

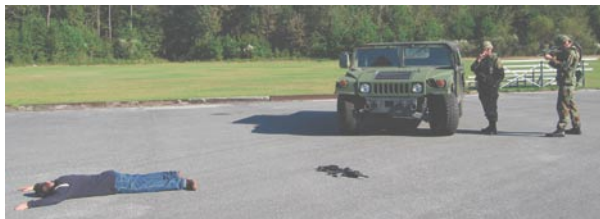

- Command the person or group to **“Move Your Arms Away From Your Body and Spread Your Feet Apart!”**

Move arms away from body and spread your feet.

- Remain vigilant over the person or group until responding forces arrive
- Continually scan the entire area for other intruders



Challenge and Password

Sign/Countersign—words or numbers can be used as the sign and countersign. For example, if the words of the day are Blue Cards and the challenge word is Blue, the correct response is Cards. The number of the day must be between two and 10, so if the number of the day is 7 and you say 3, the correct corresponding number would be 4 making the sum of 7.

Chemical Codes—used to positively identify people who wear protective masks or who are in MOPP 4. These codes are a constant changing list of numbers and letters developed into a square grid matrix to necessitate a different response to the possible combinations of challenge codes. This is a very secure method, but the most difficult to operate.

Duress Words—can be any unusual word that is not normally used in the course of routine conversation, like giraffe or scarecrow. It can be inserted into the conversation in order to communicate stealthily that a person is under some form of duress. For example “How are you today, Sgt Giraffe?”, “Have you seen a giraffe lately?” Security Forces publish duress words on a periodic basis.



Sign/countersign.

SEE
Page 217,
Quick
Reference,
**Square Grid
Matrix**

**How are you
today, Sgt Giraffe?
Have you seen a
giraffe lately?**





Search all EPWs.

Handling Prisoners and Defectors

Ref Geneva Convention, AFI 31-304 (I)

Taking enemy prisoners of war (EPW) and defectors can happen at any time. When it does, immediately notify your unit control center and request Security Forces to take custody. In the meantime, search, segregate, silence, speed to the rear, safeguard, and tag your detainees.

Search

- Immediately search the EPW with an armed colleague monitoring
- Look for anything that could be used as a weapon or an escape aid
- Thoroughly search for items of potential intelligence value
- Allow prisoners to keep uniforms and any protective clothing (e.g., bad weather and IPE gear)

Segregate

- Separate defectors, deserters, and EPWs (male and female)
- Separate military and civilians
- Separate military into subgroups
 - Officers
 - Enlisted



Separate EPWs.



Allow EPWs to keep uniforms.



EPW sensory deprivation.

Silence

- Limit communication between EPWs as much as possible
- If you don't understand the language, don't allow it
- Record anything the EPW says and send it up the chain of command

Speed to the Rear

- Contact your UCC as soon as possible
- Much of the intelligence received from the EPW is time-sensitive
- Practice EPW sensory deprivation

Safeguard

- Protect EPWs from local nationals
- Protect EPWs from friendly and allied forces
- Protect EPWs from NBCC attacks
- Protect yourself and others from EPWs

Tagging

- Complete an EPW tag if available for each detainee, weapon, and piece of equipment
- If not, use any source available
- At a minimum you should include:
 - Date/time of capture
 - Capturing unit/branch
 - Place of capture
 - Circumstances surrounding capture



Complete an EPW tag.

Audible and Visual Warnings

Ref AFMAN 10-2602

Commanders continually assess existing and potential threats, vulnerabilities, and the OPTEMPO when balancing how to protect people and accomplish mission objectives. They use:

- Alarm warning signals
- FPCONs
- MOPP levels
- MOPP variations
- Split-MOPP
- Shelter strategies



All of these will be ineffective unless you understand what they are, what they mean, and how to react. Installation warning systems vary based upon:

- Size of the base
- Number of assigned personnel
- Base layout
- How long the base has been in operation

Well established bases may have:

- A public address system
- Electronic signs
- Flags
- Cable television and computer network systems
- Tactical radios and/or land/mobile radios
- Cell phones, pagers, and an AM/FM radio broadcast system



Most deployment bases and sites, however, will be limited to a primary and secondary public address/siren system and a land mobile radio system for audible communication, and simple flags and signs for visual communication.

The command post normally operates the primary base warning/siren system while assigned and attached units maintain visual warning indicators throughout the base and at geographically separated units. Places you may see these warning flags include:

- Entry control points
- Flag poles
- Vehicles
- Shelters and workcenters
- Split-MOPP transition points
- Geographically separated units
- Maintenance areas and facilities

Note: Security Forces and Fire Protection often provide back-up audible alarms when primary systems fail and will often display alarm condition flags on their vehicles throughout operations.

A public address alarm signal announcement generally identifies the:

- Announcer
- Alarm signal
- MOPP Level
- FPCON
- Appropriate warning siren/bugle/sounds

As an example, a missile attack warning may sound something like:

“This is the base command post, Alarm Red (Alarm Blue in Korea) Missile Attack, FPCON Charlie, MOPP Level 4, Take Cover, (they may repeat this warning) then sound a wavering tone siren.”

Unit control centers will also make radio announcements throughout their radio networks.

Learn what to listen for and where to observe visual indicators at your base!

Attack Warning

Ref AFMAN 10-2602, AFVA 10-2511

If an attack warning is given, and you don't know what type of attack will or has occurred, quickly follow the protective actions for a missile attack. Always wear your helmet and body armor (if issued.) Also, always try to cover your face and ears during an attack.



Listen for announcements.

Your location is under attack by a ground force, or an attack will begin within minutes—assume MOPP Level 4 or as directed by the commander. For a small arms attack, take a defensive position behind cover. Prepare to defend yourself, your area, and watch out for Security Forces or other friendly forces to prevent fratricide. For a mortar or rocket attack, immediately shout “Incoming” and lay down in the prone position—ideally in a low lying area. If better cover is available nearby, move to that safer position between incoming rounds and avoid gathering in large groups. If you witness where mortars or rockets are fired/launched, notify Security Forces as soon as possible. Use the S-A-L-U-T-E format (see page 95) to report enemy activity and support Security Forces where possible.

Alarm Red/Alarm Blue—Attack by air or missile is imminent or in progress

- Audible wavering tone siren
- Visual red flags (Blue in Korea)

Your location is under missile attack, aircraft attack, or an attack will begin within minutes. Assume MOPP 4 or as directed by the commander.

Alarm Red/Alarm Blue, Ground Attack—Attack by ground force is imminent or in-progress

- Audible bugle
Call-to-Arms
- Visual red flags
(blue in Korea)



Bugle call means ground attack.

Trans-Attack Procedures in NBC Threat Areas

- Immediately report observed attacks or enemy force sightings to your UCC or work center
- Defend yourself under ROE—coordinate actions with others in your area

- Use buddy checks to verify proper IPE wear—assist other personnel with donning
- Assist the injured if possible, otherwise, remain in position and under cover until alarm change
- For missile attack warning, seek the best available protection (building, bunker.) If unavailable, find overhead cover
 - Remain inside vehicles/equipment (windows up, doors closed, and engine off), and don IPE
- If you're attacked without warning, don mask, move to closest protection, and don remaining IPE. Seek overhead cover (rain gear, poncho, tarps, or plastic.)
- When attack warning sounds or notification is received, vehicle and equipment operators should drive to the best available protection (building, aircraft shelter, bunker, or hangar) while passengers don IPE
- Drive vehicles and equipment into or under shelter if possible
- Keep shelters closed. Shelter teams or senior personnel in each shelter should ensure shelter doors remain closed as much as possible to limit infiltration of contamination, and control personnel entering and exiting the shelter
 - Keep shelterees away from exterior walls
 - Desks and interior rooms provide additional protection inside unhardened facilities



Use buddy checks.



Assume directed MOPP.



Seek overhead cover.



Keep away from exterior walls.

Reporting an Attack

Ref AFH 31-302

Use the **S-A-L-U-T-E** report as a quick and effective way to communicate ground enemy attack information up the chain of command.

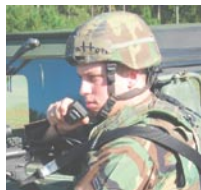

Report Area	Information to Report
S ize	The number of persons and vehicles seen or the size of an object
A ctivity	Description of enemy activity (assaulting, fleeing, observing)
L ocation	Where the enemy was sighted (grid coordinate or reference point)
U nit	Distinctive signs, symbols, or identification on people, vehicles, aircraft, or weapons (numbers, patches, or clothing type)
T ime	Time the activity is observed
E quipment	Equipment and vehicles associated with the activity

Example of a S-A-L-U-T-E Report: “Six enemy soldiers, running away from the command post, heading towards the flightline. Uniforms solid green fatigues—possibly Republic Guards. Time was 0230 hours. Equipment—AK-47 rifles, backpacks and gas mask being carried.”

Use the most expedient means necessary/possible for the urgency you place on the information you have to up channel. If your report needs to get to the commander **NOW**, use **any means** available!

- **Messenger**—most secure—most time consuming
- **Wire/telephone**—more secure than radio—not mobile and may be monitored
- **Radio**—fast and mobile—least secure. However, a secure radio lessens the possibility of being monitored and should always be used over an open net all equipment/vehicles associated with the activity

Radio Discipline

- Think before you push-to-talk
- Be brief. The radio is not a phone
- Speak clearly into the microphone and use proper call signs
- Protect your radio
- Conduct radio checks
- Always be aware of OPSEC for radios, phones, discussions and computers
- Periodically check physical condition and battery connections
- Know your unit radio manager
- DO NOT hang anything from antenna



Practice radio discipline.

OPSEC is Everyone's Job... DO NOT:

- Use ranks and names of supervisors or commanders
- Broadcast social security account numbers, phone, or credit card numbers
- Discuss classified information
- Disclose specific locations
- Use profanity



Speak clearly.

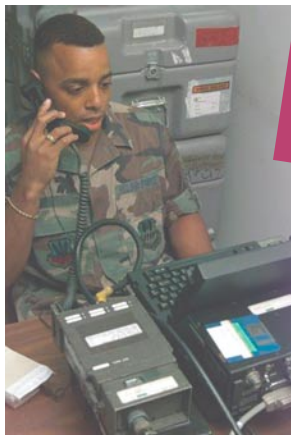

Don't discuss classified information.

SEE
Page 197,
Quick
Reference,
Procedure
Words
(Prowords)



OPSEC is everyone's job.



Don't watch flares.

Reactions to Flares

Both friendly and opposition forces rely on nighttime illumination to conduct military operations. US forces often use high-tech night vision devices to see without using illumination flares, but strategically placed ground flares with triggering devices are sometimes used in areas where it's difficult to monitor certain terrain even with the use of night vision devices. Unsophisticated opposing forces usually are not as well equipped as US forces—they don't have night vision devices and may rely heavily on low-tech aerial flares to harass friendly forces, illuminate aerial targets, or for signaling purposes. If you spot an aerial or ground flare at night, follow these common procedures to maximize your protection and safety:

- Remain stationary and assume the prone position—don't move.
- Report flare activity to your unit control center
- Don't look toward a burning flare—protect your night vision by closing or covering one eye (preferably your “shooting” eye) while observing with the other. Close both eyes if you can
- Wait until the flare(s) is completely burned out before moving
- Your eyes may take up to 30 minutes to readjust to darkness after exposure to light



Notify control center.



Vehicle and Equipment Protection, Marking, and Decontamination

Ref AFMAN 10-2602

When attack warning

occurs, drive your vehicle to your designated shelter or seek cover beneath the best available overhead protection. Turn-off the engine, close hatches and doors, install protective covers, and pre-position M8 Paper on horizontal surfaces. Equipment operators should likewise shut-down equipment, close access doors and panels, install protective covers, and pre-position M8 Paper. Take cover!



Seek overhead cover and close facility doors.

After the attack (when you're released) check the pre-positioned M8 Paper for contamination. If contaminated, remove the barrier material and dispose as contaminated waste. Notify your UCC of the contamination status. Check the asset again with M8 Paper. If contaminated with a liquid chemical agent, operationally decontaminate the asset within 1 hour from



Remove contaminated barriers.

the time of contamination. Non porous surfaces (i.e. glass, unpainted metal) won't let liquid chemical agents quickly penetrate the surface—that represents the most dangerous area on a contaminated surface. Use M295 decon kits and decon surfaces that must be continuously touched. A 5% chlorine bleach solution can augment the decontamination process (if available).



Can't decon textiles.

There's no operational method of decontaminating textiles (canvas storage covers, seatbelts, webbing, carpet) once they've become contaminated with a liquid chemical agent. Place barrier material over these items or replace them if possible.

Contaminated vehicles and equipment are not unserviceable—don't abandon or stop protecting them if they were previously

contaminated. If you wear the right IPE and follow appropriate measures, you can continue to use contaminated vehicles and equipment.



Follow procedures when using contaminated vehicle.

Mark vehicles and equipment with the appropriate NBC hazard marker (or equivalent) to show they were contaminated. For vehicles, place the marker in the lower center portion of the windshield. Annotate the AF Form 1800-series operator's form when the marker is placed.



Mark vehicles.

SEE
Page 202,
Quick
Reference,
NBC
Hazard
Markers

Equipment operators should use the appropriate inspection form outlined in

the equipment technical data. Include the date and time of contamination, the agent type, and the location of the contamination on the vehicle. If the inspection form is not available or itself becomes contaminated, provide the same information, along with the vehicle registration or equipment identification numbers to your UCC.

Vehicle operators and passengers should place barrier materials on seats if they or seat areas are (or were previously) contaminated. Body heat and pressure (from sitting) increases the potential for liquid chemical agents to penetrate the overgarment. Also, consider covering steering wheels with barrier material—this is especially important for vehicles with open cabs or driver compartments.

Convoy Procedures

Ref AFJMAN 24-306

If you must travel in a vehicle convoy, pay close attention to the predeparture convoy briefing that's applicable to both drivers and riders.



Vehicles are force multipliers.

Drivers:

- Be qualified to operate the vehicle
- Inspect your vehicle every 24 hours
- Annotate AF Form 1800, Operator's Inspection Guide and Trouble Report
- Ensure your vehicle is properly equipped
 - Check for spare tires, tire changing equipment, first aid kit, flashlight, fire extinguisher, etc.
- Guard vehicle anytime convoy has stopped

Drivers and Riders Must Know:

- Primary and alternate travel routes, checkpoints, and timelines
- Everyone must be alert to possible threats or hazards during the entire convoy and be prepared to defend against them
- Order of movement
- What to do during road blocks and breakdowns
- Speed limits
- Distance and intervals

Convoy Attack Procedures

Air Attack

- Sound a series of short blasts on the vehicle horn
- Pull vehicle off the road, maintain intervals
- Seek cover away from the vehicles
- Notify UCC—give time, location, and activity using S-A-L-U-T-E
- Remain under cover until "All Clear"



Watch vehicle interval spacing.



Watch for ambush.

Ambush (IED, Rockets, Mortars, Small Arms)

- Take an alternate route
 - Notify UCC—give time, location, and activity using S-A-L-U-T-E
 - Speed up and drive out of the kill zone or halt convoy
 - Dismount and return fire as a last resort
 - Assemble and move out of the area
 - Assemble at a safe distance
- NOTE: See page 42 for IED threats.

Vehicle Break Down

- Repair the vehicle, if possible
 - If irreparable, tow it if possible
 - If towing isn't possible, call for a wrecker
- If convoy must leave, two people must remain in defensive posture
 - Ensure personnel left behind have equipment, food, water, communications, and currency
 - If vehicle may fall into enemy hands, destroy or disable it

Roadblock

- Lead vehicle notifies convoy
- All vehicles stop
- Disperse in a defensive posture
- Assess the roadblock
- Watch for booby-traps or ambush
- Look for IEDs made to look like roadside garbage or debris
- Report the location and nature of the roadblock to UCC
- If roadblock can be moved or breached, do so immediately
- If the roadblock can't be moved or breached, switch to an alternate route



Go around roadblocks.

Weapons Skills–Rifle

Ref TO 11W3-5-5-41, AFMAN 31-229, TO 11W3-5-5-24

You must be able to competently handle your assigned weapon. Prior training, along with this information, will keep you ready if you must fulfill your force protection role.

Weapon Safety

- Never point your weapon at anyone or anything you're not willing to shoot
- Consider all weapons as loaded
- Clear all weapons during issue and turn-in at a designated safe place or as instructed by superiors
- Keep your finger off the trigger until you're prepared to engage your target
- Don't shoot anything you can't positively identify
- Know what's behind your target
- Keep weapon on safe until ready to shoot



Don't shoot at anything you can't identify.



Keep weapon on safe until ready to shoot.

M16A2 Characteristics



- Maximum rates of fire:
 - Semiautomatic, 45 rpm
 - Automatic (3-round burst), 90 rpm
 - Sustained, 12 to 15 rpm
- Maximum range, 3938 yds (3600 m)
- Maximum effective ranges:
 - Point target, 602 yds (550 m)
 - Area target, 875 yds (800 m)

M4 Carbine Characteristics



- Maximum rates of fire:
 - Semiautomatic, 45 rpm
 - Automatic (3-round burst), 90 rpm
 - Sustained, 12 to 15 rpm
- Maximum range, 3938 yds (3600 m)
- Maximum effective ranges:
 - Point target, 550 yds (500 m)
 - Area target, 660 yds (600 m)

Clearing Procedures

- 1** Attempt to place weapon on Safe

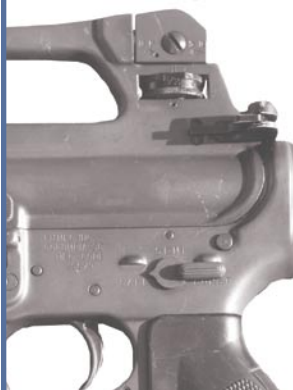

- 2** Remove magazine from weapon by pressing magazine release button



- 3a** Lock bolt to rear. Visually inspect chamber and receiver area for live rounds or obstructions



- 3b** If bolt is in forward position, push in on BOTTOM of bolt release, then pull charging handle all the way to rear. After bolt has been locked back, ensure charging handle is placed fully forward



- 4** Check to make sure weapon is on safe



Disassembly (Fieldstrip)

- 1 Clear weapon
- 2 Send bolt forward
- 3 Remove sling
- 4 Remove handguards (may use buddy system)
- 5 Separate upper and lower receivers
- 6 Remove bolt carrier group and disassemble
 - a Pull back charging handle and bolt carrier
 - b Remove bolt carrier, then charging handle
NOTE: Use charging handle to hold small parts
 - c Remove firing pin retaining pin
 - d Remove firing pin from the rear of the bolt carrier
 - e Push bolt and carrier group together, rotate cam pin 1/4 turn, then lift out of the bolt carrier
 - f Remove bolt assembly from carrier
 - g Press the rear of the extractor relieving spring pressure and press out extractor pin
 - h Remove extractor and spring (do not separate spring from extractor)
- 7 Remove buffer and action spring

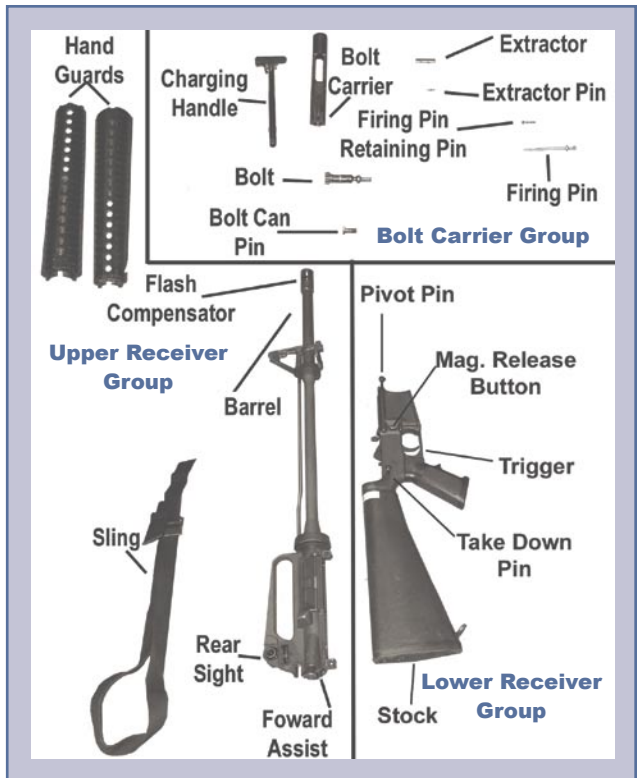

Function Check

- Start with a CLEARED WEAPON, bolt forward, on SAFE
- Pull the trigger
- Weapon should not dry fire (hammer should not fall)
- Place on SEMI and pull the trigger
- Weapon should dry fire (hammer falls)
- Hold the trigger to the rear and charge the weapon
- Release trigger slowly (you should hear an audible click)
- Repeat semi test five times
- Place the weapon on BURST and pull the trigger
- Weapon should dry fire (hammer falls)
- Hold the trigger to the rear and release the weapon charging handle three times
- Release the trigger. Pull the trigger and hammer should fall





M16A2 and M4 Carbine Ammunition

- M855 Ball with green tip
- M856 Tracer with orange tip

These are the standard rounds for the M16A2 and M4 Carbine.

Loading Procedures

- Visually inspect rifle to ensure weapon is on safe and no ammunition is present in chamber or receiver
- Send bolt forward by slapping bolt release on left side of weapon
- Insert magazine



Insert magazine.



Know what's behind your target.

Firing the Weapon

- Pull charging handle fully to the rear and release (allow bolt to slam forward)
- Place weapon to Semi
- Aim and shoot

Reloading Procedures

- Remove empty magazine
- Insert new magazine
- Slap bolt release to allow bolt to go forward
- Continue to fire



Insert new magazine.



Remove empty magazine.

Unloading Procedures

- Remove magazine
- Ensure weapon is on safe
- Lock bolt to rear
- Visually inspect chamber and receiver area

Immediate Action Procedures (SPORTS)

If the weapon fails to fire:

- S** Slap upward on bottom of magazine to ensure magazine is fully seated
- P** Pull charging handle to rear
- O** Observe to see if a round or cartridge casing was ejected and chamber and receiver area are clear (if chamber or receiver is not clear, proceed to remedial action)
- R** Release charging handle (allow bolt to slam forward)
- T** Tap forward assist button to ensure bolt is fully forward
- S** Shoot

Remedial Action Procedures

If immediate action does not correct problem, or an obstruction is found during immediate action:

- Clear weapon
- Check again for jammed cartridge case Note: inspect closely, a ruptured cartridge case can be difficult to see
- If cartridge case is detected, use a cleaning rod to remove
- Reload weapon
- Select Semi
- Fire



Pull charging handle.



Shove rod into barrel to clear jammed cartridge.

Fundamentals of Shooting and Firing

- Establish steady firing position
- Establish GOOD stock weld (face should be in firm contact with stock of weapon.) Ensure tip of nose is no further than two fingers width behind charging handle to establish proper eye relief
- Align sights (sight adjustment alignment)
- Align sights on target (sight picture)
- FOCUS on FRONT SIGHT
- Place no more than first pad of finger on trigger
- Hold your breath
- With steady, increasing pressure, pull trigger to rear
- After weapon recoils, realign sights and start fundamentals process again (do not break stock weld)
- Remember to be consistent with face placement, sight alignment, sight picture, and breadth control. Be as motionless as possible while pushing trigger to rear

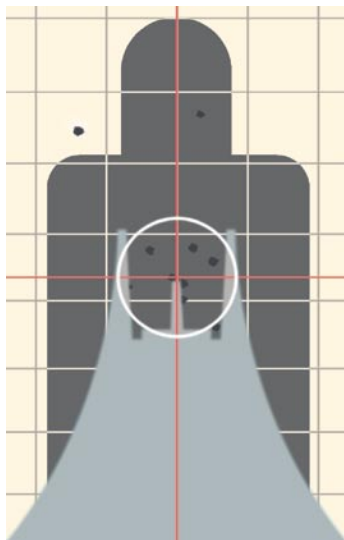

Good sight picture.

M16A2 Sight Adjustment Alignment



front sight

- Front sight adjustments are used to make elevation changes
- To adjust the front sight, use the tip of an ammunition round to depress the **detent** then rotate the sight clockwise to raise the bullet path or counter clockwise to lower the bullet path
- One click = 3/8 inch (0.9 cm) at 82 ft (25 m) or 1 3/8 inch (3.5 cm) at 328 ft (100 m)

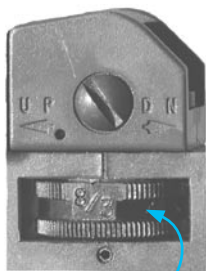
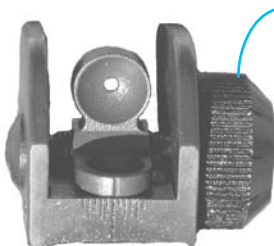
rear sight,
elevation

rear sight, windage

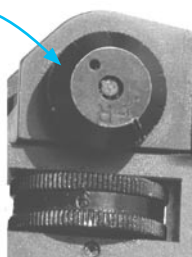

- Rear sight adjustments are used to make changes in the right and left movement (windage) of the bullet and elevation or range distance corrections
- Windage correction is one click = 1/8 inch (0.3 cm) at 82 ft (25 m) or 1/2 inch (1.25 cm) at 328 ft (100 m)
- Elevation correction is one click = 1/4 inch (0.7 cm) at 82 ft (25 m) or 1 inch (2.8 cm) at 328 ft (100 m). Elevation adjustment on the rear sight is to adjust for proper target distance

Mechanically Zeroing the M16A2

Mechanically zeroing your weapon is only necessary when the weapon zero is questionable, the weapon is newly assigned to you, or the weapon sights have been serviced.

Adjust the **front sight post (1)** up or down until the base of the front sight post is flush with the **front sight post housing (2)**



Adjust the **elevation knob (3)** counterclockwise, as viewed from above, until the **rear sight assembly (4)** rests flush with the carrying handle and the 8/3 marking is aligned with the index line



Position the **apertures (5)** so the unmarked aperture is up and the 0-200 meter aperture is down. Rotate the **windage knob (6)** to align the index mark on the 0-200 meter aperture with the long center index line on the rear sight assembly

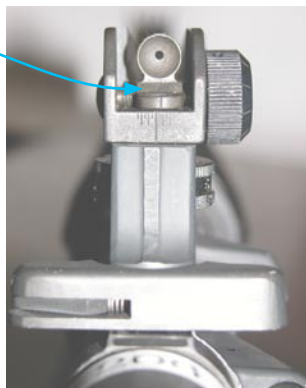

Care and Cleaning

Cleaning Equipment

The ideal cleaning kit consists of:

- Handle section, three-rod sections, swab holder, and swabs
- Bore, chamber, small arms cleaning brush (nylon bristle toothbrush), and pipe cleaners
- Cleaner, Lubricate Preservative (CLP), ½-oz bottle
- Other authorized cleaning equipment:
 - Cleaning compound, rifle bore, (RBC)
 - Dry cleaning solvent, (SD).
 - Lubricating oil weapons (semi-fluid LSA)
 - Lubricating oil, arctic weapons (LAW)
 - Under all but the coldest arctic conditions, LSA and CLP are the lubricants to use in temperatures above -10°F (-23°C)
 - LAW is used when temperatures range below -10°F (-23°C)

Don't use any two lubricants at the same time—clean the weapon thoroughly before changing lubricants. Also, wear eye protection when cleaning your weapon.



Cleaning the Weapon

- 1** First clean, inspect, and lubricate the upper receiver and barrel assembly



- 2** Next clean, inspect, and lubricate the charging handle and bolt carrier group



- 3** Clean, inspect, and lubricate the lower receiver and extension assembly

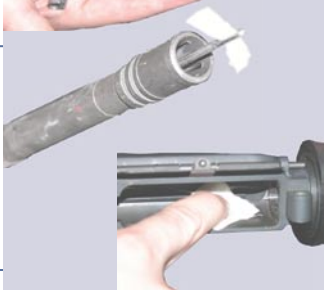

- 4** Finally clean, inspect, and lubricate the magazine



- 5** Now that the weapon is clean it can be assembled in the reverse order of disassembly

Field Expedient Cleaning

- Clear weapon
- Clean bolt carrier
- Clean barrel

Note: Required daily when in a field environment.

Weapons Decontamination

Ref AFMAN 10-2602

Operational and Thorough Decontamination

- Operationally decontaminate Chem/Bio contaminated weapons within minutes after exposure (if possible)
- Use M291 or M295 decon kits
- Use water-soaked rags to remove decon powder residue
- To thoroughly decontaminate, disassemble and soak or submerge in 5% chlorine solution for the duration identified by NBCD-Cell controllers
- Always wear gloves when cleaning or handling previously contaminated weapons
- Decontaminate cleaning tools (cleaning rods and brushes) with a 5% chlorine solution
- Dispose of used weapons cleaning materials as contaminated waste



Operational decon.



Use vapor barriers.

Contaminated Weapons Handling in Armories or Closed Spaces

If not thoroughly decontaminated, previously contaminated weapons may become vapor hazards to unmasked people within closed or unventilated areas. When a previously contaminated weapon is not needed for immediate use, double-wrap in a plastic bag and mark the bag. The bag will reduce the residual hazard and prevent exposure to low-level Chem/Bio vapors.

Weapons Destruction

If necessary, weapons must be destroyed to prevent enemy use. The commander will give the destruct order (if that time comes.) Weapons destruction methods include:

- Mechanical—axe, pick, sledgehammer, or crowbar—do not use this method to destroy munitions
- Burning—gasoline, diesel, JP-4, oil, incendiary grenades, cutting torches, other
- Gunfire—artillery, machine-guns or rifles
- Demolition—requires suitable explosives or ammunition
- Disposal—bury in the ground or dump weapons in streams or marshes (you can also disassemble and scatter the parts over a wide area)
- Destroy the same part on all weapons



Destroy the same part on all weapons.

NOTES

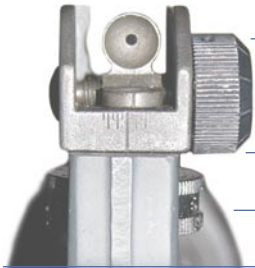

#2 pencil works best

Weapons Skills–Pistol/M9

Ref TO 11W3-3-5-1, AFMAN 31-229

You must be able to competently handle your assigned weapon. Prior training, along with this information, will keep you ready if you must use your weapon.



Weapon Safety

- Never point your weapon at anyone or anything you're not willing to shoot
- Consider all weapons as loaded
- Clear all weapons each time you handle them
- Keep your finger off the trigger until you're prepared to engage your target
- Don't shoot anything you can't positively identify
- Know what's behind your target
- Keep weapon on safe until ready to use



Characteristics

- Weapon will fire both single and double action. Safety feature includes a manual decocking lever and firing pin block
- Maximum effective range is 55 yd (50 m) with a maximum range of 1.1 miles (1800 m)



Nomenclature

- Slide assembly consists of the decocking lever, firing pin, extractor, barrel, firing pin block, locking block, and sights
- Receiver assembly consists of disassembly button and lever, slide stop, trigger, magazine catch assembly/release button, grips, hammer, and lanyard loop
- Magazine assembly consists of the floor plate, magazine spring, follower, and magazine tube

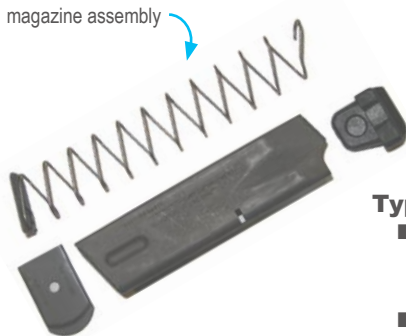
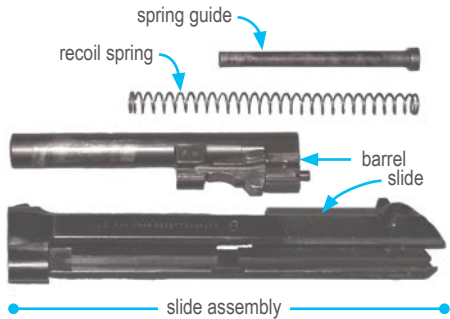

Types of Ammunition

- M882 Ball—
124-grain jacketed bullet,
basic cartridge for field use
- No tracer round is
authorized for use in the M9



Clearing Procedures

1 Holding the pistol in the right hand, move the **decocking lever** **DOWN** to the **SAFE** position



2 Press the **magazine release button** and remove the magazine



3 Grasp the slide with the left hand, cupping the **left hand over the ejection port**



4 Next, rotate the weapon slightly to the right while **pushing the slide to the rear**



5 Catch the ejected round in the left palm and lock the slide to the rear



6 **Visually inspect** the chamber and receiver area to ensure there is no ammunition present



Disassembly (Fieldstrip)

- Clear the weapon and then allow the slide to go forward
- Hold pistol in right hand with muzzle slightly elevated
- Press in on the disassembly lever and hold
- Rotate the disassembly lever down until it stops
- Pull slide and barrel assembly forward and remove from the receiver—use caution when separating recoil spring and guide as they're under spring tension and can cause injury
- Lift and remove the barrel and locking block assembly from the slide



Function Check

- Clear the weapon
- Release the slide and insert an empty magazine
- Retract the slide, once the slide moves all the way to the rear, the magazine follower should hold the slide to the rear
- Remove the magazine
- Ensure the decocking lever is down, release the slide forward (hammer should fall fully forward)
- Press/release the trigger (firing pin block should move up and down)
- Move decocking lever UP to FIRE position
- Press the trigger (weapon should dry fire double action)
- Press the trigger and hold to rear
- Retract and release slide



- Release the trigger (you should hear audible click and hammer should not fall forward)
- Press trigger to check single action (hammer should fall)



Destruction of Weapons

Follow same methods as rifle destruction (see page 115).

Loading Procedures

- Visually inspect pistol to ensure decocking/safety lever is in safe position (down)
- Insert magazine
- Send slide forward by depressing slide stop
- Place weapon on fire



Reloading Procedures

- Remove empty magazine
- Insert new magazine
- Release slide
- Fire



Immediate Action Procedures

If the weapon fails to fire:

- Ensure decocking /safety lever is in the fire position (up)
- Smack upward on bottom of magazine to ensure it is fully seated
- Rack the slide to the rear and release
- Fire



Remedial Action Procedures

If immediate action procedures do not correct problem:

- Remove magazine
- Eject chambered round
- Insert new magazine
- Rack slide to rear and release to chamber new round
- Attempt to fire
- If pistol still does not fire, replace ammunition



Fundamentals of Pistol Shooting

- Establish firm hand shake grip (ensure no part of hand is above tang of weapon)
- Push shooting hand towards target, non-shooting hand pulls back towards shooter
- Raise sights to eye level and align
- Place aligned sights on target
- FOCUS on FRONT SIGHT
- Place first pad of finger on trigger
- Hold breath
- With steady, increasing pressure, pull trigger to rear
- After weapon recoils realign sights and apply fundamentals for subsequent shots
- Remember to be consistent with sight alignment, sight picture, and breath control. Be as motionless as possible while pulling trigger to rear



Good sight picture.



Section 5

Survive





Alarm Black–Attack Is Over, Initiate Base Recovery

Ref AFMAN 10-2602, AFVA 10-2511

- Audible steady tone siren
 - Visual Black Flags
 - Assume MOPP 4 or as directed by the commander
 - NBCC hazards (facility damage, UXO, NBC contamination) are likely to be present but may not yet be marked or reported
- Perform self-aid and buddy care (SABC), and perform immediate decontamination (if contaminated)
 - Base specialized and unit Post-Attack Reconnaissance (PAR) teams begin surveys when directed by the commander
 - Commanders will release mission critical personnel in phases



Perform SABC.



Check for contamination.

Post-Attack Reconnaissance

Ref AFMAN 10-2602

- Remain in a shelter or under cover unless otherwise directed—mission essential personnel outside only. Keep exposure to a minimum and remember contamination avoidance
 - When contamination is present and movement is required, don't move between sectors or zones without prior approval—follow appropriate contamination control procedures
 - Check the prepositioned M8 Paper throughout the immediate area for signs of contamination
 - Check all detectors in your area—listen for audible alarms
- Check for UXOs
 - Report positive and negative findings to your UCC
 - Negative detector readings don't necessarily equate to hazard-free assets; liquids may have absorbed but low level vapors may still be present

- Replace prepositioned contaminated M8 Paper with new paper—mark date and time placed on the paper
- Treat contaminated M8 Paper as contaminated waste
- Avoid contact with objects and areas that may be contaminated
- Use M291/M295 kits to operationally decontaminate areas you must touch to perform your mission (within the first hour of contamination if possible)
- If double or triple layer sheets of barrier material covered contaminated assets, carefully remove the outer layer, and replace it as time permits
- Treat contaminated barrier material as contaminated waste
- If contamination is found in the area, identify assets as contaminated
- Mark contaminated assets according to Air Force installation procedures
- Place NBC marking kit signs or their approved equivalents on all sides of contaminated assets
- Mark and update signs at Chem/Bio zone transition points once established
- At night, use portable lights or chemical light sticks to call attention to markings, however, use only white light to read M8 and M9 Paper

SEE
Page 218,
Quick
Reference,
Grid Maps



Mark contaminated buildings.

SEE
Page 204,
Quick
Reference,
**10-Foot
Rule**

- Follow 10-Foot Rule procedures, if implemented or directed

Post-Attack Damage and Casualty Checklist Items

- 1** Call your UCC or SRC representative and report:
 - a** Name/rank
 - b** Unit
 - c** Phone/radio net
 - d** Date/time/type of contamination
- 2** Report the location of the incident:
 - a** Facility/**grid coordinates**/other relevant information
 - b** Report any known damage:
 - c** Condition of area/facility/equipment/vehicles/assets
- 3** Report the number of casualties:
 - a** Dead = D
 - b** Injured = I
 - c** Missing = M
- 4** Report casualty disposition:
 - a** Evacuated to Casualty Collection Point
 - b** Applied first aid
 - c** Awaiting transport

Unexploded Ordnance (UXO)

Ref TO 60A-1-1-4, 60A-1-1-22, AFI 91-201, Vol 4, AFI 32-3001

UXOs are hazards that pose a risk of causing injury or death! UXOs can be conventional, chemical, biological, or any combination thereof. UXOs can be missiles, bombs, rockets, mines, or other devices that range in size from very small to large. If you discover or suspect an object is a UXO, follow the 4R's—Recognize, Record, Retreat, and Report.



SEE
Pages 2-7,
Critical,
UXO
Survey and
Reporting

Recognize

- Identify the UXO as a hazard
- Remember features; size, shape, color, and condition (intact or leaking)

Record

- Mark it from where you are
- DO NOT move closer—most UXO have a minimum **lethal** radius of 300 ft (100 m), and a much greater danger radius
- Use the standard UXO or mine markers or whatever material available
- Ensure markings are visible in all directions and at night

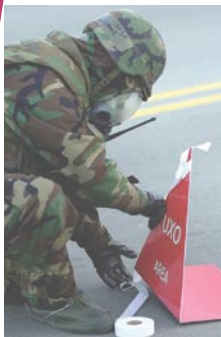

Mark UXO.

Do not attempt to remove anything that is on or near a UXO

Retreat

- Evacuate all personnel and equipment from the area
- Retreat the same way you entered or via a clear, well-traveled path
- If evacuation is impossible, isolate or barricade the area to restrict area access

Report

- If reporting by radio, transmit from a minimum safe distance of 25 ft (8 m) for handheld or 100 ft (30 m) for vehicle radios or you could detonate some UXOs



Warn others.

- Provide all pertinent details: size, shape, color, condition, landmarks, grid coordinates

WARNING:
Modern ordnance is complex and sensitive and can incorporate anti-disturbance or anti-removal devices. Clearing any UXO without proper training, tools, and information could be LETHAL. DO NOT attempt to move or disturb these items.



Follow UXO checklist.

Protective Measures—three methods are used to protect people and equipment: evacuate, isolate, and barricade

Evacuation—upon identification of a UXO:

- Retire to a safe distance and enforce evacuation measures when evacuation is possible
- Evacuate and use available cover to an initial distance of 300 feet for munitions smaller than 5 inches in diameter, and 500 feet for munitions 5 to 10 inches in diameter
- 1,000 feet for 10 to 20 inches in diameter and 1,500 feet for munitions greater than 20 inches
- Do not remain in the immediate danger area any longer than necessary
- Seek SRC guidance via your UCC to determine the appropriate evacuation distances for UXO present



Stay out of craters.

Isolate—sometimes, for mission-related, operational, or other reasons, evacuation of people or equipment isn't possible or it's impossible to leave a particular area. In these situations, isolate the assets (people, equipment, and operations) from UXO by establishing a safe area and limiting exposure. Contact EOD if you must work in an area you suspect UXO or landmines may be present.

Barricade—limits blast and fragmentation from an explosion

- Suppressive barricades are constructed around a UXO to suppress an explosion, shock wave, and fragments
- Protective barricades are constructed around exposed resources to shelter from overpressure and fragments
- Use natural protective barriers whenever possible
- If natural barricades are inadequate, construct artificial barriers
- While building barricades, DO NOT disturb the UXO and wear all appropriate protective equipment (to include Kevlar helmets and personal body armor)



Small.

Small UXO—generally less than 3 inches in diameter, carefully construct a double-wall thickness of sandbags within 3 to 4 ft around the UXO. Stack the sandbags to at least 3 ft high and thick enough (minimum two sandbags deep) to protect personnel and equipment from the blast and fragmentation.



Medium.

Medium UXO—generally from 3 inches to 10 inches in diameter, a wall thickness of four or five sandbags within 5 to 7 ft should surround the UXO. Stack the sandbags to a height of at least 5 ft to protect assets.

Large UXO—over 10 inches in diameter are generally too large to build effective barricades around them. In these cases, barricade the equipment and personnel activity areas.



Large.

Reporting Unexploded Ordnance

UXO Spot Report—clearly identifies the location of the UXO, briefly describes the item, and provides the opportunity to include other significant information.

- The first-echelon report that is sent when an observer detects UXO
- Forward the UXO Spot Report to the Unit Control Center or chain of command
- Once the information is recorded, the report is sent or called in to the SRC EOD representative by the fastest means available

Warning—do not transmit or key radios within 8 meters (25 feet) of a UXO when using a handheld radio or within 30 meters (100 feet) of a UXO when using a vehicle radio. It may cause a detonation.



Don't transmit within 25 ft.

Unexploded Ordnance Checklist Items

- 1 Call your UCC or SRC to report
 - a Unit
 - b Date/time
- 2 Report the location and cordon size of the UXO
 - a Bldg number, grid coordinate, distance from landmark or building, etc.
 - b Explain how the UXO is marked and the distance between the UXO and the marker
- 3 Report the "Class" or shape (i.e., "Bravo 1" UXO)
 - a See Critical section, page 3, for UXO identification
- 4 Report any identifying features
 - a For example, the color, size, length, and markings
- 5 Report the condition of the UXO
 - a Is it leaking?
 - b Is it intact?
 - c Is it broken?
- 6 Report any other significant information

Contamination Control

Ref AFMAN 32-4005

In a chemical and/or biological environment, contamination control is essential to sustained operations. You must remove contaminated IPE within 24 hours by processing through a contamination control area (CCA.)

Collective Protection

NBC collective protection enhances survival. Collective protection systems provide overpressure, filtration, and controlled entry and exit, and a contamination-free environment for relief from continuous wear of IPE. Collective protection supports two mission sustainment areas that quickly erode in an NBC environment; personnel rest and relief (breaks and sleeping), and work relief (command and control, medical treatment, MOPP recovery time after maximum work effort.) Transportable and expedient collective protection measures are also used to augment existing capabilities. Your unit shelter management teams are trained to operate and maintain collective protection systems (where assigned.)



Aircrew life support has its own aircrew CCA.



Temporary structure with collective protection.



A CCA is a form of thorough decon.



Follow CCA procedures.

Contamination Control Area (CCA)

A form of thorough decontamination incorporates these features:

- Transportation drop off point
- Entrance and holding area
- Contact hazard area (CHA)
- Vapor hazard area (VHA)
- Mask decon and refurbishment area
- Toxic free area (TFA) where you can operate without chemical protective equipment

SEE
Pages 200
and 201
Quick
Reference,
CCA
Layouts

Trained CCA

assistants will usually help you process safely through the CCA. You can expedite your CCA processing experience by closely listening to the CCA assistants and doing exactly what they tell you to do, and by reading and understanding each processing step before you perform that task.



Use the buddy system.

Watch out for problems that might arise in the CCA processing area during high wind conditions.

M8 Chemical Agent Detection Paper

Ref TO 11H2-14-5-1

Detection

- Detects G and V nerve agents and H and L blister agents
- Provides a manual liquid detection capability
- Supplied in booklets of 25 perforated pages of paper containing chemical agent sensitive dyes
- Inspect prior to use. Discard M8 Paper that shows signs of wetness, wrinkling, dirt, damage, or discoloration
- If M8 Paper is not pre-positioned, blot (do not rub or scrub) over nonporous surface like glass or bare metal surfaces suspected to be contaminated
- Mark date and time of placement

Operational Limitations

- Use only white light to read
- M8 Paper will function in snow, rain, and sleet, but not if saturated with water
- If M8 Paper is saturated with water, it should be replaced
- M8 Paper reaction is immediate at temperatures above 32°F and slow to several minutes below 32°F
- Dye will rapidly deteriorate at temperatures above 125°F
- Some items such as wasp spray and cleaning supplies may produce false positives.

Positive M8 Paper Results

When liquid nerve or blister agents contact M8 Paper, a color change takes place. **Report color changes to your UCC.**

Gold or Yellow

G-series nerve

Pink or Red

H- or L- series blister

Blue or Dark Green

V-series nerve

Red-brown*

GF nerve agent

*This positive indication is not presented on the color comparison chart inside the cover of the M8 packet.

Warning—Always wear protective gloves when touching the detector paper. Do not place the detector paper in or near your mouth or skin.



Deposition pattern #1.

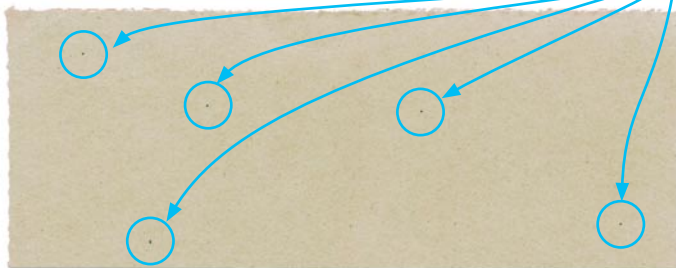

Deposition pattern #2.

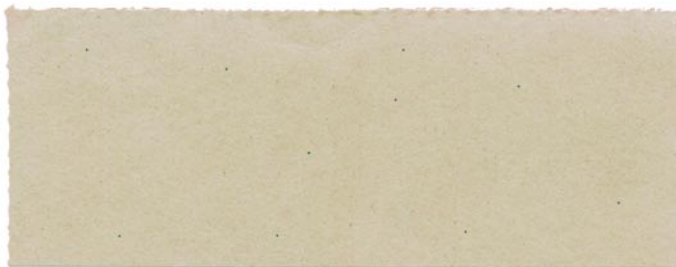

Deposition pattern #3.

**Can
you
see
these
green
spots?**

**Now,
can
you
see
these?**

M8 Paper showing VX nerve contamination at approximately 250 microns, with three examples of various deposition patterns.

The average size of a VX-Nerve liquid droplet that reaches the ground is expected to be 200-250 microns in size—at the beginning detectable threshold for the average eye to see, under optimum light levels. Now, imagine reading M8 Paper results through your protective mask, during darkness, with a flashlight, and under a high OPTEMPO! Knowing what to look for will help you prepare for this difficult challenge.



200-250 micron drops will be difficult to see with the naked eye.

M9 Chemical Agent Detection Paper (Tape)

Ref TO 11H2-2-21

Intended Use

M9 Paper is worn on clothing or attached to vehicles or equipment. Preferred operating range is 32°F to 125°F, with relative humidity up to 100%.

Sensitive Dyes

M9 Paper contains sensitive dyes that change color in the presence of liquid chemical agents (G- and V-series) and H and L blister agents.

Color Changes

Color changes identify agent presence, (**Not Agent Type**.) Liquid agent positive indicators include: pink, any shade of red, red-brown, and red-purple. Blue, yellow, green, gray, or black spots are not from a liquid chemical agent.



Inspection

Inspection is a user responsibility. Inspect shipping bag and dispenser. If shipping bag is torn or open, discard roll. Check dispenser for shelf life date stamp and discard if shelf life has expired. If dispenser is crushed, wet, or cutting edge is missing, discard. Check paper for discoloration, tears, creases, or dirt. If paper comes apart from backing, discard.

Operational Life

One year in temperate, tropic, and desert regions. Two years, in frigid zones after removal from the shipping bag. The shelf life of M9 Paper (Tape) is 8 years from the manufacture date.

Operational Limitations

- Temperatures above 125°F
- Brake fluid, hydraulic fluid, gasoline, aircraft, and automotive grease, and insect repellents cause false responses
- M9 Paper does not provide rapid results at temperatures below 32°F, but will function

Warning—Always wear protective gloves when touching the detector paper. Do not place the detector paper in or near your mouth or skin.

Nuclear Attack/Radioactive Individual Protective Actions

Ref AFMAN 10-2602

Initial Actions

- Store or remove flammable materials from the populated shelter areas and work centers
- If advanced warning of a detonation is received, find shelter that provides the greatest protection
- Use window barriers and shielding to improve protection for buildings or shelters
- Upon seeing the nuclear flash, seek protection from the blast wave, heat, and flying debris
- If a detonation occurs without warning, immediately drop to the ground in a prone position. Tightly cover your face with both hands. Do not move until the initial blast wave and any reflected blast waves have passed



Follow-on Actions

- Remain within protected areas or shelters until directed otherwise
- Perform damage assessment, self-aid and buddy care, and reporting actions
- Decon yourself by brushing dust/fallout off of your clothing or by blotting away with adhesive tape—Rinse exposed skin
- Limit radiation exposure by minimizing time spent outside in contact with fallout, and maximizing time in shelter and distance from radiation



Nuclear and Biological Protection

Ref AFMAN 32-4017, AFMAN 10-2602

Nuclear Concerns

The primary products of a nuclear detonation are:

- Blast and shock
- Thermal radiation (heat)
- Nuclear radiation
- Ballistic debris for surface and shallow sub-surface bursts

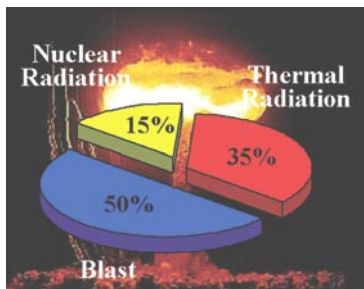

Nuclear blast energy distribution.

Electromagnetic Pulse (EMP)

May cause widespread communications and/or electrical problems after a nuclear detonation.

Types of Nuclear Radiation

Can affect you initially at the time of the burst, or delayed as fallout.

- Alpha—harmful if internalized
- Beta—may cause skin burns; harmful if internalized
- Gamma—destroys living cells; harmful when exposed
- Neutron—emitted only during detonation, but 20 times more harmful than Gamma

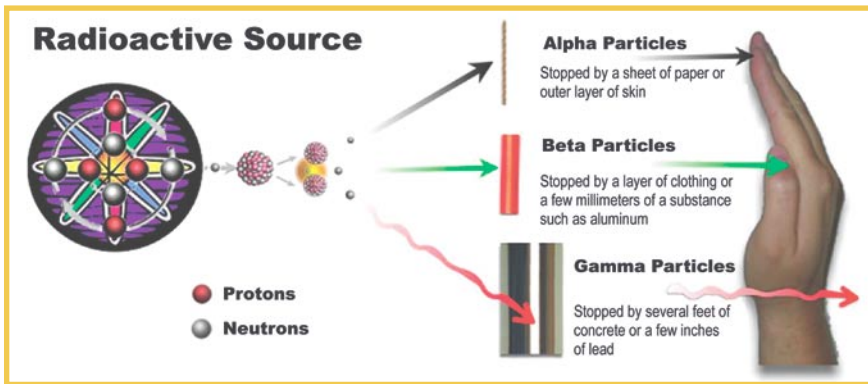

Radiation hazards.

Radiation Dispersal Device (RDD)—is any device that causes the purposeful dissemination of radioactive material across an area without a nuclear detonation. An RDD could function as a terror weapon or terrain-denial mechanism. One type of RDD could function by using conventional explosives to blow-up and scatter radioactive source debris across a relatively small area—also known as a dirty bomb.

Radiation Sickness

- Caused by radiation destroying cells within the body at a rate the body cannot overcome
- Radiation sickness is not contagious
- Early symptoms are nausea, vomiting, loss of appetite, and illness
- Subsequent symptoms, severe body fluid loss, internal hemorrhaging, and diarrhea

Individual Decontamination

- Radioactive material can't be neutralized—it must be removed from affected surfaces
- Brush dust from uniform and footwear
- Thoroughly wash dust from skin and body
- Avoid breathing dust by covering nose/mouth with dust mask, handkerchief, or equivalent
- Limit time spent in fallout environment

Depleted Uranium (DU)

An extremely dense radioactive metal 40% less radioactive than natural uranium

- DU presents a moderate hazard
- Minimize time near the radioactive source
- Maximize the distance between the source and yourself

Military uses include:

- Protective shielding in armored vehicles
- Munitions designed to penetrate heavy armor
- Aircraft counterbalances
- 30 mm Armor Piercing Incendiary (API) GAU-8 munitions

Biological Agent Individual Protective Actions



Immunizations and Preventative Medications

Keep your immunizations current.

Physical Health

Poor physical health reduces your body's ability to resist and fight infections. Regular exercise and balanced meals build and maintain your body's natural resistance to diseases.



Hygiene

Frequently washing with soap and water prevents and eliminates most areas where biological agents multiply. Protecting skin cuts and abrasions also denies biological agents additional pathways of entry into your body.



Sanitation

Wash all fruits and vegetables before eating and ensure that all foods are thoroughly cooked. Additionally, drink only from approved water sources, and only use ice that's approved for consumption.

Biological Warfare and Biological Terrorism

Ref AFMAN 10-2602

Biological agents include viruses, bacteria, fungi, and toxins cultured from living organisms that are developed to produce death or disease in humans, animals, or plants. Biological agents may be found as liquid droplets, aerosols, or dry powders and can be adapted for use as a terrorist weapon.

Advantages of Biological Agents as Weapons:

- Easy to obtain, inexpensive to produce
- Potential for high number of casualties
- Can overwhelm medical services and resources
- Threat of use, and use may create widespread panic

Routes of Infection:

- Skin
 - Cuts
 - Abrasions
 - Mucous membranes (eye, nose, mouth)
- Gastrointestinal
 - Food—Potentially significant route of delivery
 - Water—Capacity to affect large numbers of people
- Respiratory
 - Inhalation of spores, droplets, and aerosols
 - Aerosols are an effective delivery method

What can be done?

- Awareness
- Individual and collective protection
- Detection and characterization
- Treatment
- Safe practices



Keep immunizations up-to-date.

Immunizations and Treatment—keeping immunizations current is paramount. In some cases, you may be issued a pretreatment based upon the deployed region and the specific threat. If you're given a prevention or treatment, like Cipro™ for example for inhaled anthrax, you **MUST NOT** deviate from taking your prescribed dose at the required interval until directed otherwise.

Disease	Incubation	Symptoms	Transmission	Protection
Inhaled Anthrax	2-6 days Range: 2 days-8 weeks	Flu-like symptoms Respiratory distress (Anthrax infection of skin sequence: Initial itching bump on skin, 1-3 cm painless ulcer, dead skin tissue center; fever)	Aerosol inhalation No person-to-person transmission	3 of the 6 anthrax shots could protect; Cipro™ after infected
Botulism	12-72 hours Range: 2 hrs-8 days	Difficulty swallowing or speaking Weakness Respiratory dysfunction No sensory dysfunction No fever	Aerosol inhalation Food ingestion No person-to-person transmission	Personal hygiene to protect; Antitoxins after infected
Plague (pneumonic and bubonic)	1-3 days by inhalation	Sudden onset of fever, chills, headache Pneumonic: cough, chest pain Bubonic: painful lymph nodes	Person-to-person transmission in pneumonic forms	Hygiene and gloves, mask; Antibiotics after infected
Tularemia "pneumonic"	2-5 days Range: 1-21 days	Fever, cough, chest tightness, painful and difficult respiration	Inhalation of agents No person-to-person transmission but laboratory personnel at risk	Respiratory protection; Antibiotics longer than 7 days after infected
Smallpox	12-14 days Range: 7-17 days	High fever and muscle pain; itching; abdominal pain; delirium Rash on face, extremities, hands, feet; confused with chickenpox which has less uniform rash	Person-to-person transmission	Hand wash, immunization to protect Respiratory protection— Treat symptoms after infected Airborne precautions— Negative pressure Clothing and surface decontamination

Operational Differences Between Chemical Warfare and Biological Warfare Agents

Ref AFMAN 10-2602

Chemical and biological agents can be employed with equally deadly effects. However, there are some distinct differences in their employment and detection. One difference is the quantity of agent needed to generate a widespread effect and the methods needed to carry-out their effective use. It takes considerable effort to deliver a chemical weapon that holds a militarily significant amount of agent needed to produce widespread coverage. Bacteria, viruses, and biological toxins, on the other hand, can be delivered with relative ease when compared to chemical agent delivery. This table shows some of the differences:

	Chemical Warfare Agent	vs.	Biological Warfare Agent
Release Site of Weapon	Quickly discovered, possible to cordon off contaminated/attack areas		Difficult to identify, probably not possible or useful to cordon off area of attack
Manifestation of Symptoms	Rapid, usually minutes to hours after an attack		Delayed, usually days to weeks after an attack (except toxins)
Distribution of Affected Patients	Downwind area near point of release		Widely and rapidly spread, difficult to track or predict
Signatures	Easily observed (colored residue, dead foliage, pungent odor, dead insect and animal life)		Typically no characteristic signatures immediately after attack
Medical Countermeasures	Chemical antidotes		Limited vaccines, antibodies, and/or antitoxins and antivirals for some agents
Casualty Management and Contamination	After decontamination and/or weathering, no further need for protective measures or risk of further contamination		Patient isolation/quarantine crucial if communicable disease is involved

During increased threats and in high threat areas, trained teams continuously monitor bases with specialized detectors that can warn you of the presence of chemical and biological warfare agents. Listen closely for public address announcements and radio updates, and listen for alarms from detectors that are spread throughout the base to provide you with an early warning of attack.

Chemical Agent

Nerve Agents

Individual Protective Actions

Characteristics

- Some may have a fruity smell or camphor odor, others may be odorless
- Most lethal of all agents
- Symptoms can be immediate; lethal within minutes.
- Affects nervous system
- May be inhaled, ingested, or absorbed through the skin
- In vapor, solid, or liquid form
- Antidotes may be effective even if given to a victim having advanced symptoms, as long as the victim continues to breathe

Symptoms

- Pinpointing of pupils and muscular twitching
- Dimness of vision and runny nose
- Tightness of chest and difficulty in breathing
- Excessive sweating, drooling, nausea and vomiting, and involuntary urination and defecation
- Convulsions, coma, death
- Intermittent cumulative exposures to very low amounts can lead to the same ultimate effect as a single exposure to a higher amount

Protection

- Take Pyridostigmine Bromide tablets (P-Tabs) as directed
- **NOTE: These are effective against Soman (GD) only**
- Wear IPE (MOPP 4), or as directed
- Practice contamination avoidance and expedient decontamination
- Use nerve agent auto-injectors when experiencing symptoms
- Flush eyes and open wounds with water and protect from further contamination
- Use decon kits to absorb agents on skin
- Seek medical attention as soon as possible after any exposure or as soon as symptoms appear

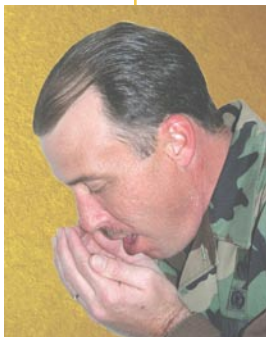

Nerve Agent Antidote Injectors

Ref AFH 36-2218

Use Auto-Injectors for Nerve Agents ONLY!

- Wear protective mask
- Remove one atropine injector (small injector) from a Mark 1 Kit and remove safety cap
- Position injector against injection site, apply firm even pressure until needle is triggered
- Hold injector firmly in place for 10 seconds
- Carefully remove injector and bend needle, attach to an OG pocket
- Remove the 2 PAM Chloride injector (large injector), remove safety cap, and repeat the steps above



WARNING: If within 5-10 minutes after administration of the first set of injectors, your heart beats very quickly and your mouth becomes very dry, do not inject a second Mark 1 kit.

- If mild symptoms persist after 10 to 15 minutes, have a buddy administer a second Mark 1 kit
- Seek medical help



Remove cap



Inject antidote



Pin to pocket



Mark 1 kits.

With Severe Symptoms

- Administer all three Mark 1 kits followed by the diazepam injector to prevent convulsions. In cold weather, store kits in an inside clothing pocket to protect the antidote from freezing. Do not wait between kits.



Use buddy care.



Diazepam injector.

Warning: Do NOT use more than three Mark 1 kits. The white injector, diazepam, is to be used when there is a presence of severe nerve agent poisoning symptoms, and all three sets of the Mark 1 kits have been administered. Never use your injectors on somebody else!

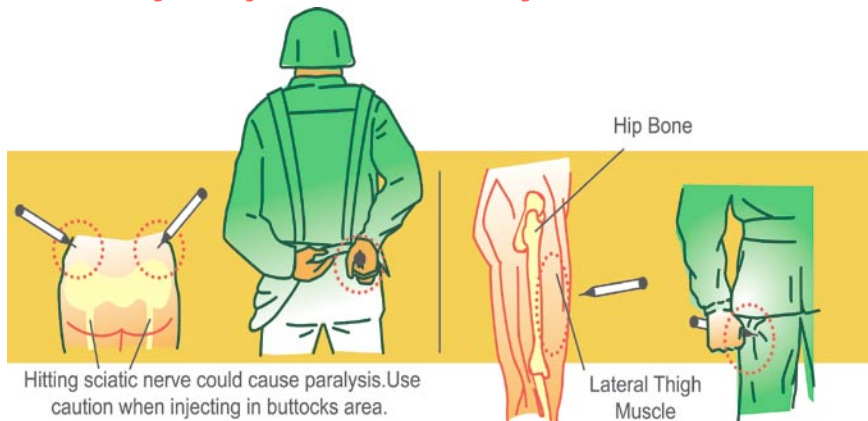

Chemical Agent Individual Protective Actions

Blister Agents

Characteristics

- Designed more to incapacitate
- Some also known as mustard agents
- May smell like garlic or have a fishy/musty odor
- Employed in liquids, or solids
- Destroys tissues, injures blood vessels, causes blisters
- Some violently irritate mucous membranes in eyes and nose
- Affects eyes, respiratory tract, and skin
- May be lethal if inhaled, ingested, or through skin absorption
- Incapacitation may last for days or weeks

Symptoms

- Symptoms may be immediate or take up to four hours to appear
- May cause stinging sensation upon contact
- Blisters any tissue it contacts
- Red, watering eyes
- Blurred vision
- Light sensitivity
- Blindness
- Sweaty groin and armpits are more susceptible to blister agents

Protection

- Wear IPE (MOPP 4), or as directed
- Avoid contaminated surfaces if possible
- Practice contamination avoidance and operations decon
- Decon skin with M291/M295 decon kits
- Seek medical attention as soon as possible after any exposure or as soon as symptoms appear



Toxic Industrial Material (TIM)

TIM hazards may be manufactured, stored, distributed, or transported in close proximity to airbases. Most present a vapor (inhalation) hazard. They may also reduce the oxygen concentration below that required to support life.

Category	Type of Material	Primary Uses
Agriculture	Insecticides, Herbicides, Fertilizers	Agriculture, Vector Control
Industrial	Chemical and Radiological Materials	Manufacturing Processes, Cleaning, Water Treatment
Production and Research	Chemicals and Biological Materials	Laboratories, Storage Facilities
Radiological	Nuclear Fuel, Medical Sources	Nuclear Power Plants, Medical Facilities, Industrial Plants, Laboratories

Protection

The most important action is immediate evacuation outside the hazard's path (if feasible.) **The protective mask, ensemble, and military standard collective protection filters are not designed to provide protection from TIMs.** If evacuation is impractical, implement shelter-in-place procedures.





Seek cover.

Shelter-In-Place

Ref HQ AFCEA Protective Actions Planning Guide for Individuals and Facility Managers

Shelter-in-place isn't the answer to every situation. However, it may be the only short-term practical solution to protect large populations in dormitories, workcenters, and office complexes following certain hazardous material (HAZMAT) incidents. Shelter-in-place is most effective when occupants pre-plan and practice contingency actions. Here are some shelter-in-place tips:

Outdoor Hazard While You're Outside a Building—an outdoor hazard release may result from an accident during storage, transport, fire, or the result of a malicious act.

- Take cover
- Notify others
- Don available protective equipment
- Report the event
- Perform self-aid and buddy care as needed
- Seek nearest building or safest area
- Shelter-in-place until otherwise directed
- Follow shelter or facility manager instructions



Notify others, take cover.

Outdoor Hazard While You're Inside a Building—to a very limited degree, buildings act as natural filters. In some cases, shelter-in-place can offer limited short-term protection against airborne hazards that originate outdoors. Purging a building after an airborne hazard has passed can eliminate hazards that have infiltrated the interior.

- Turn off HVAC and exhaust fan(s), fans, and combustion heaters



Turn off HVAC.



Stay indoors.

- Secure classified material
- Move to a central safe room or area
- If directed, evacuate upwind or crosswind
- Notify unit control center
- Upon return, purge and ventilate buildings when directed:
 - Open operable windows and doors
 - Turn on smoke and exhaust fans
 - Turn on HVAC air handlers and fans

Outdoor Hazard While You're Inside an Expeditionary or Temporary Structure—

may include tents, temporary buildings, trailers, or portable hard-wall shelters used by military forces in CONUS or OCONUS deployments. If the analysis of hazardous materials threat indicates an accidental or deliberate release could occur without warning:



Temporary structure.

- Operate HVAC systems, including window units, in the **closed or recirculation mode** at all times
- If a release warning is provided, follow the previous guidelines
- Aircrew (before or after taxiing) actions include closing hatches and windows and using oxygen masks (if available)
- Passengers might evacuate aircraft as required by the situation

Inside hazard while you're inside the building—an inside release could result from an industrial chemical spill or biological or radiological material release from supplies, equipment, or mail (as in the case where a contaminated letter affected a US post office.)

Buildings generally inhibit the exchange of inside and outdoor air. An affected building could remain unusable without a significant rehabilitation effort. Many hazards produced by an inside release can be much more severe than a similar release outdoors.



- Turn off HVAC, exhaust fan(s), fans, and combustion heaters
- Report the incident to the Fire Department or Security Forces
- Close and seal doors and windows to contain the hazard
- Secure classified material
- Evacuate upwind or crosswind
- Notify unit control center



Turn off HVAC.

MCU-2 Series Protective Mask

Ref TO 14P4-15-1

With a serviceable C2A1 filter canister installed, the MCU-2 Series is the first line of defense for your face, eyes, and respiratory tract from chemical and biological warfare agents, radioactive dust particles, and riot control agents (such as tear gas.)



Operational Considerations

- Do not over tighten the mask. Over tightening may actually cause leaks
- Check the mask for leaks every time you don it by performing a “leak” check
- Don the mask quickly—it should be donned and sealed before you take another breath
- The mask is a filter respirator—it doesn’t supply or produce oxygen
- The mask is ineffective in environments with insufficient oxygen to support life
- The mask is ineffective in industrial chemical environments such as ammonia or chlorine spills, or within carbon monoxide atmospheres
- Don’t loosen the head harness straps for comfort if you wear a hood over the outlet valve. If loosened, you could become unprotected against toxic agents or suffocate by carbon dioxide
- Don’t remove your mask outdoors if you become overheated in cold weather until your head cools and any sweat has dried—frostbite may result
- Use buddy checks when possible



Second skin installed.



Properly store mask inside carrier.



Place chin in chin cup.



Pull head harness over head.

MCU-2 Series—With the filter canister installed, head harness straps loose and inverted over the front of the mask, and the outsert removed, fit test the mask. Note: An unshaven face could prohibit a mask seal.

Warning: Women should remove hair clips, pins, etc., and let their hair hang freely before donning mask.

- Hold the outlet valve assembly in palm of one hand. Push hair back away from hairline. Place mask on face forcing chin cup very tightly against chin
- Keeping the hair out of the way, pull the head harness over the head using the quick don tab—the facepiece should come well up on the forehead but shouldn't extend over the hairline at any point
- Push mask as high on face as possible. Look down at nose to ensure mask is centered. Hold in this position with one hand until temple straps are tightened
- Adjust temple straps using small jerking pulls until the mask feels snug and both sides feel the same
- Ensure the headpad or skullcap is centered at the high point of rear of head. Adjust if necessary.
- With both hands, run a finger under each temple tab front-to-back to check for snugness and remove stray hair from sealing area



Check for leaks.



Tighten head harness.



Check seal.

- Grasp a neck strap in each hand and tighten with small jerking motions
- Grasp a forehead strap in each hand and tighten with small jerking motions
- Shake head quickly from side-to-side and up-and-down. Adjust mask straps as necessary
- The mask should be comfortable on the face with no straps cutting or pinching or so tight that the nosecup presses painfully on the nose
- Ensure the canister is sealed. Cover the canister inlet port and inhale until the lens deflects, then hold your breath. If lens stays deflected, this is a good indication of a proper fit. If it doesn't, readjust and recheck your mask until you get a proper seal
- You can now remove the mask. Loosen only the mask neck straps. Grasp mask by outlet valve assembly and remove by pulling down, outward, then up
- Shake or wipe out any accumulated moisture before storage



Remove mask from carrier.



Quickly don mask.

Don MCU-2 Series Mask Without Hood Attached or While Wearing CPO—Note:

Those who require vision correction should already be wearing MAG-1 prescription spectacles, or have an Advantage 1000 optical insert installed in your mask (as applicable)

- Stop breathing and close your eyes
- Remove your helmet
- Open the mask carrier
- Grasp and remove the mask from the carrier (don't grasp filter canister)
- Hold outlet valve assembly in palm of one hand. Using free hand, push forehead hair aside. Place mask on face, forcing chin-cup tightly against chin
- Grasp tab and pull head harness over your head centering the headpad at the back of your head—ensure your ears are between the temple and neck straps—make necessary strap adjustments for proper fit
- Block the outlet valve cover openings with your hand and forcefully exhale so air escapes past the edges of your facepiece
- Locate the filter canister, cover the inlet port, and inhale. The lens should collapse and stay collapsed while you hold your breath.
- If it does, the facepiece is sealed. If it doesn't, make necessary adjustments and recheck
- Open your eyes and resume normal breathing

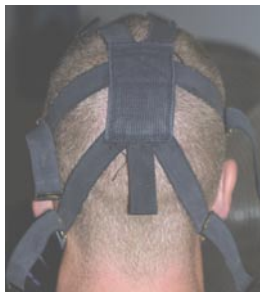

Center head harness.

■ CPO only:

- Pull hood over mask
 - Close slide fastener completely and secure closure hook-and-pile fastener tape up as far as top of slide fastener
 - Place edge of hood around edge of mask and secure hook-and-pile fastener tape
 - Snap barrel locks together under chin. Squeeze barrel lock ends together. Pull both drawcord ends at the same time and slide barrel locks up to hood to maintain hood seal around the mask
 - Have another person check hook seal around mask to ensure hood is positioned properly and skin is not exposed. Some discomfort may be experienced in the neck area of CPO coat due to the close fitting in the neck area
- Don your helmet and close the carrier



Pull hood over head.



Secure all closures.

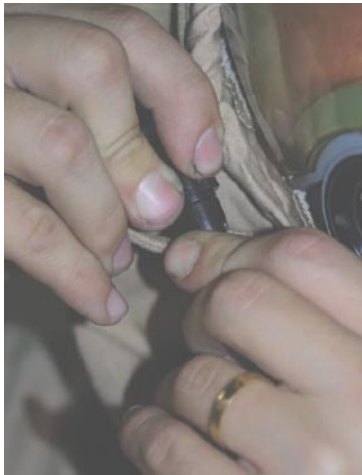

Loosen barrel locks.

Doff MCU-2 Series Mask Without Hood Attached or While Wearing Uncontaminated CPO—Warning: If you're contaminated or are in a contaminated environment, proceed to a CCA for mask removal instructions.

- Remove your helmet
- If CPO is worn:
 - On CPO jacket, unfasten barrel locks, loosen hood drawcord, and pull hood from head so that the hood hangs behind neck and shoulders
- Loosen lower neck straps
- Grasp mask by outlet valve assembly and remove by pulling down, outward, and up over your head
- Shake or wipe any moisture or frost accumulations from inside of mask
- Properly stow mask in carrier
- Don your helmet



Open hood, pull back.

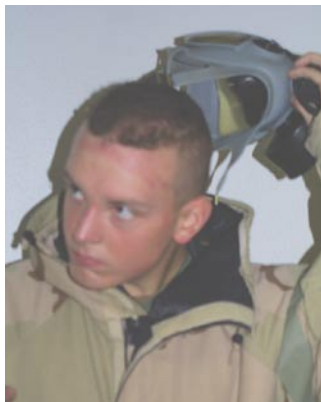

Remove mask, shake out moisture.

Install Hood on MCU-2 Series—Ensure the hood is serviceable, and then attach it to your mask for instant use.

- Unfold hood and loosen neck cord
- Turn hood inside out
- Spread hood flat, with the face opening up
- Unfasten underarm straps and hood temple straps
- Place mask face down on hood and insert the canister through face opening. Adjust mask neck straps so ends are within one-inch of buckles
- Fasten hood temple straps over mask temple tabs
- Turn hood right side out
- Stretch hood face opening around top and sides of mask lens
- Make sure hood covers top of the outlet valve cover
- In moderate temperatures (30°F to 90°F) secure hood over voicemitter/ outlet valve assembly
- If hood is to be worn in a biological or radiological environment, in extreme temperatures (<30°F or >90°F), stretch lower part of face open over outlet valve portion of the assembly so that the outlet valve cover is outside hood. This procedure is not authorized in a chemical environment.
- Raise back of hood up and over face of mask. Reverse head harness over face of mask
- Fold sides of hood so that it crosses over the outlet valve.
- Tuck underarm straps into V at outlet valve.
- Raise folded hood up to cover the eye lens outsert and fit it snugly under the reversed head harness. The hood material must not obstruct the quick-don tab on the head harness
- Stow mask in carrier



Inspect hood.



Secure temple straps.



Fold hood and stow mask.

Don MCU-2 Series with Hood Attached or While Wearing BDO—Note: Those who require vision correction should already be wearing MAG-1 prescription spectacles or have an Advantage 1000 optical insert installed in your mask as applicable

- Stop breathing and close your eyes
- Remove your helmet
- Open the mask carrier with one hand
- Grasp mask with the other hand and remove it from the carrier (Don't grasp the filter canister)
- Put chin in chin cup very tightly. With your free hand push hair back away from hairline. Press mask snugly against your face
- Grasp tab and pull head harness over your head. Center the headpad (or skull cap) at the back of your head—ensure your ears are between the temple and neck straps
- Grasp a neck strap in each hand and tighten with small jerking motions
- Block the outlet valve cover openings with your hand and forcefully exhale so air escapes past the edges of your facepiece
- Locate the filter canister, cover the inlet port, and inhale. The lens should collapse and stay collapsed while you hold your breath
- If it does, the facepiece is sealed. If it doesn't, make necessary adjustments and recheck
- Open your eyes and resume normal breathing
- Pull the hood up and over your head and shoulders—make sure the cape is beneath the neck cord
- Tighten neck cord until cord is snug around neck, then secure the neck cord at base of the hood
- Pass straps under arms from the rear to front and fasten the ends to the base of the hood
- Don your helmet and close carrier



Chin in chin cup.

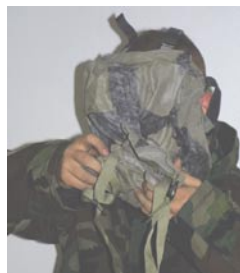

Pull head harness over head and check seal.



Pull hood over head, tighten neck cord, and attach underarm straps.

Doff MCU-2 Series with Hood Attached or While Wearing Uncontaminated BDO—Warning: If you're contaminated or are in a contaminated environment, proceed to a CCA for mask removal instructions

- Remove your helmet
- Unfasten underarm straps
- Loosen neck cord and underarm straps
- Pull back of cape forward over head and leave hood suspended from front of mask
- Loosen neck straps and grasp mask by outlet valve assembly and remove by pulling down, outward, and up
- Be careful of low temperatures and wind chill factors in cold climates
- Shake or wipe any moisture or frost accumulations from inside of hood or mask
- Reverse head harness over mask facepiece
- Stow mask and hood in carrier
- Don your helmet and close carrier



Loosen cords and straps.



Pull hood over head.



Pull out and up on mask.



Remove mask.

M45 Land Warrior Chemical-Biological Mask

Ref TM 3-4240-348-10, TO 14P4-18-1

With a serviceable C2A1 filter canister installed, the M45 is the first line of defense for your face, eyes, and respiratory tract from chemical and biological warfare agents, radioactive dust particles, and riot control agents (such as tear gas.)



Operational Considerations

- Only extra-small and large M45 masks are issued to hard-to-fit USAF personnel
- Do not over tighten the mask. Over tightening may actually cause leaks
- Check the mask for leaks every time you don it by performing a “leak” check
- Don the mask quickly—it should be donned and sealed before you take another breath
- The mask is a filter respirator; it doesn’t supply or produce oxygen—**As such, it’s ineffective in environments with insufficient oxygen to support life**
- The mask is **ineffective in industrial chemical environments** such as ammonia or chlorine spills, or within carbon monoxide atmospheres
 - Don’t loosen the head harness straps for comfort if you wear a hood over the outlet valve. If loosened, you could become unprotected against toxic agents or suffocate by carbon dioxide
 - Don’t remove your mask outdoors if you become overheated in cold weather until your head cools and any sweat has dried—frostbite may result
 - Use buddy checks when possible



M45 with second skin installed.

M45 Fit—With the filter canister installed, head harness straps loose and inverted over the front of the mask, fit test the mask. Note: An unshaven face could prohibit a mask seal.

- Hold the outlet valve assembly in palm of one hand. Push hair back away from hairline, put chin in chin pocket, and press the mask snugly against your face.
- Keeping the hair out of the way, pull the head harness over the head using the quick don tab—the facepiece should come well up on the forehead
- Adjust forehead straps so mask facepiece seats well up on your forehead, but not more than one-half inch into your hairline and within one inch of your ears
- Adjust temple and neck straps until the mask feels snug and both sides feel the same and don't cut into your ears
- Ensure your pupils are positioned above the center of the eyelens
- Ensure the nosecup seats comfortably on your nose
- Ensure the canister is sealed. Cover the canister inlet port and inhale until the mask collapses, then hold your breath. If the mask remains collapsed, this is a good indication of a proper fit. If it doesn't, readjust and recheck your mask until you get a proper seal
- You can now remove the mask. Loosen only the mask neck straps. Grasp mask by outlet valve assembly and remove by pulling down, outward, then up
- Shake or wipe out any accumulated moisture before storage



Chin in chin cup.



Head harness over head.



Check mask seal.

Don M45 Mask Without Hood Attached or While Wearing CPO

- Stop breathing and close your eyes
- Remove your helmet
- If worn, take off your glasses
- Open the mask carrier
- Grasp and remove the mask from the carrier (don't grasp filter canister)
- Press chin in chin pocket, push hair back away from hairline, press mask snugly against your face
- Grasp tab and pull head harness over your head centering the headpad at the back of your head—ensure your ears are between the temple and neck straps
- Tighten both neck straps at the same time—pull each neck strap tab out approximately two inches to seat the mask
- Block the outlet valve cover openings with your hand and forcefully exhale so air escapes past the edges of your facepiece
- Locate the filter canister, cover the inlet port, and inhale. The facepiece should collapse against your face and stay collapsed while you hold your breath.
- If it does, the facepiece is sealed. If it doesn't, make necessary adjustments and recheck
- Open your eyes and resume normal breathing



Remove from carrier.



Chin in chin cup. Pull head harness over head.



Tighten head harness.



Mask centered on head.



Perform leak test.

■ If CPO is worn:

- Pull CPO hood over mask
- Close slide fastener completely and secure closure hook-and-pile fastener tape up as far as top of slide fastener
- Place edge of hood around edge of mask and secure hook-and-pile fastener tape
- Snap barrel locks together under chin. Squeeze barrel lock ends together. Pull both drawcord ends at the same time and slide barrel locks up to hood to maintain hood seal around the mask
- Have another person check hook seal around mask to ensure hood is positioned properly and skin is not exposed. Some discomfort may be experienced in the neck area of CPO coat due to the close fitting in the neck area



Pull hood over head and secure.



Close carrier.

■ Don your helmet and close the carrier



Loosen hood fasteners.

Doff M45 Mask Without Hood Attached or While Wearing Uncontaminated CPO—Warning: If you're contaminated or are in a contaminated environment, proceed to a CCA for mask removal instructions

- Remove your helmet
- If CPO is worn:
 - On CPO jacket, unfasten barrel locks, loosen hood drawcord, and pull hood from head so that the hood hangs behind neck and shoulders
- Loosen lower neck straps



Pull hood over head.

- Grasp mask by outlet valve assembly and remove by pulling down, outward, and up over your head
- Be careful of low temperatures and wind chill factors in cold climates
- Shake or wipe any moisture or frost accumulations from inside of mask
- Don your helmet and stow mask in carrier



Pull mask out and up.



Remove and shake out moisture.

Install Hood on M45—Ensure the hood is serviceable, and then attach it to your mask for instant use.

- Remove the mask eyelens outserts
- Align hood eye ring openings with mask eye lenses and secure
- Replace eyelens outserts
- In moderate temperatures (30°F to 90°F) secure hood over voicemitter/outlet valve assembly
- In extreme temperatures (<30°F or >90°F) secure hood to expose voicemitter/outlet valve assembly
- Raise back of hood and head harness over front of mask to allow the hood to hang inside-out
- Stow mask in carrier

Don M45 with Hood Attached or While Wearing BDO

- Stop breathing and close your eyes
- Remove your helmet
- Take off your glasses if worn
- Open the mask carrier with one hand
- Grasp mask with the other hand and remove it from the carrier (Don't grasp the filter canister)
- Put chin in chin pocket, with your free hand push hair back away from hairline. Press mask snugly against your face
- Grasp tab and pull head harness over your head. Center the headpad at the back of your head—ensure your ears are between the temple and neck straps
- Tighten both neck straps at the same time—pull the neck strap tabs out approximately two inches to seat mask
- Block the outlet valve cover openings with your hand and forcefully exhale so air escapes past the edges of your facepiece
- Locate the filter canister, cover the inlet port, and inhale to collapse the mask. The facepiece should stay collapsed while you hold your breath. If it does, the facepiece is sealed. If it doesn't, check for hair or other material between mask seal and the face. Make necessary adjustments and repeat until a seal is attained
- Open your eyes and resume normal breathing
- Pull the hood up and over your head and shoulders
- Secure the hood closures and underarm straps
- Don your helmet and stow mask in carrier

Doff M45 with Hood Attached or While Wearing Uncontaminated BDO—Warning: If you're contaminated or are in a contaminated environment, proceed to a CCA for mask removal instructions

- Remove your helmet
- Loosen hood fasteners and underarm straps
- Reach up beneath hood and loosen lower neck straps
- Grasp front of mask and pull mask forward then up and over your head
- Be careful of low temperatures and wind chill factors in cold climates
- Shake or wipe out any accumulated moisture before storage
- Raise back of hood and head harness over front of mask to allow the hood to hang inside-out
- Don your helmet and stow mask in carrier

Canisters and Filters

Ref TO 14P4-1-151, TO 14P4-15-1, TO 14P4-18-1

Warning: Filter canisters will not afford protection from industrial chemicals, ammonia, or carbon monoxide, or in areas with insufficient oxygen to support life.

A serviceable C2A1 filter canister installed on a serviceable M45 or MCU-2 Series mask creates an effective first line of defense for your face, eyes, and respiratory tract from chemical and biological warfare agents, radioactive dust particles, and riot control agents (such as tear gas.) You must install a serviceable canister on your mask when the threat of attack is possible and prior to entry

into a toxic chemical or biological agent environment.

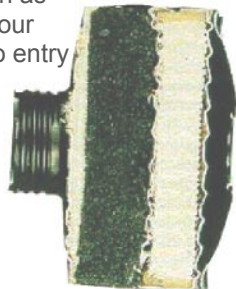

cross section

Replace Canisters and Filters

- When directed by higher authority or there's clear indication of imminent use of Chem/Bio agents
- Within fifteen days after any exposure to Chem/Bio agents (except blood agents)
- As soon as it is safe to do so when exposed to blood agents
- As soon as it is safe to do so when mechanically damaged (i.e., breaks or cuts in material or edge of seal, a bent or split connector, etc.)
- If filter has been immersed in water or wetted in any way
- If you experience excessive breathing resistance (clogged filter/canister element will increase breathing resistance but will not impair the ability of the filter to remove agents)

Service Life

Once removed from the factory sealed package:

- 52 weeks—Cold humid and warm moderate climate
- 39 weeks—Hot dry climate
- 10 weeks—Hot humid climate

Document DD Form 1574

- Date canister removed from the sealed package
- Canister lot number

Mask Second Skin

Ref TO 14P4-15-1, TM 3-4240-348-10, TO 14P4-18-1

In a chemical warfare environment, you're protected by a combination of the agent-resistant facepiece, second skin, and hood. Although all three components protect you against Chem/Bio agents in vapor form, the second skin and hood provide increased liquid agent protection against a penetrating liquid agent. It's designed to interface with

the CPO and BDO suits. The second skin is made of agent resistant rubber and fits over the facepiece of your mask. The second skin covers exposed exterior portions of the mask's facepiece.

Precautions:

- Ensure the second skin is installed on your mask prior to entry into a potential chemical warfare environment
- Second skin cannot be changed in a contaminated environment
- Replace the second skin if it shows signs of cracks, tears, or splits
- Don't use second skin without the eyelens outsert(s) installed
- Avoid over stretching holes in the second skin. Use caution when pulling second skin over flanges of outlet valve and side voicemitter ring
- Don't damage outlet valve disk while stretching second skin over the outlet valve body
- When installing canister, make sure second skin does not get pulled down inside the threaded area
- When using a sharp instrument to remove a contaminated second skin, be careful to only cut the second skin and not the mask or straps



Second skin cannot be changed in a contaminated environment.

Second Skin Installation:

- Remove canister from facepiece
- Remove detachable microphone (if equipped)
- Remove eyelens outsert(s)
- Remove drink tube from receptacle
- Remove outlet valve cover
- Remove head harness temple straps from mask
- Orient second skin over mask
- Place second skin on top of mask
- Pull drink tube through lower center hole on second skin
- Stretch lower center hole over outlet valve body... position so it's beneath the drink tube
- Stretch second skin over side voicemitter retaining ring (if installed)
- Stretch sides and top over lens opening(s)
- Pull temple straps through slots in second skin and reattach head harness
- Place thumbs at bottom of the front voicemitter and work second skin around retaining ring
- Adjust second skin as needed to ensure as much mask is covered as possible around voicemitter and inlet valve
- Reinstall eyelens outsert(s) ensuring second skin eyelens opening(s) are covered
- Reinstall outlet valve cover and replace drink tube into receptacle
- Reinstall canister
- Reinstall detachable microphone (if equipped)



Second skin.



Facepiece.

Drinking Through the Mask

Ref TO 14P4-15-1, TM 3-4240-348-10, TO 14P4-18-1

Maintaining proper hydration and rest discipline helps to offset the adverse effects of thermal build-up, dehydration, and associated stress factors. To drink through your mask, you must have a serviceable M1 canteen cap installed on your canteen. Here's a way to drink while you're wearing your mask.



Warning—Do not connect the drink tube to your canteen until all mating surfaces have been checked and are free of contamination. First, decon your canteen and mask's drink tube with an M291 or M295 decon kit if necessary. Take care not to break the mask seal while pressing on the outlet valve cover or using the drinking system.

Warning—Do not connect

the drink tube to your canteen until all mating surfaces have been checked and are free of contamination. First, decon your canteen and mask's drink tube with an M291 or M295 decon kit if necessary. Take care not to break the mask seal while pressing on the outlet valve cover or using the drinking system.

NOTE: Liquids other than water may leave residue in tube. Sugars in some liquids can block the tube and decay, causing illness. Only use water unless otherwise approved.

- Decontaminate the M1 canteen cap and drink tube coupling before use in suspected contaminated environment
- If you're wearing a hood, uncover the outlet valve cover to access the drink tube
- Steady your mask and remove the drink tube coupling from the outlet valve cover
- Use buddy system to drink if buddy available



Use buddy system.

- Push on the outlet valve cover and grasp the internal drink tube between your teeth
- Remove your canteen from its carrier and flip open the M1 cap lid
- Blow through the internal drink tube while coupling the external drink tube into the M1 cap until it seats (you should feel some resistance. If resistance is not felt, your drinking system is leaking. Do not drink! If system leaks, pinch and hold drink tube and seek help.)
- If system is sealed, invert the canteen above the voicemitter, and drink
- After several swallows, stop sucking and return the canteen to the upright position. Air should replace the water you drank from the canteen through the drink tube. If necessary, blow into the drink tube to return the canteen to its original shape. Repeat the drinking procedure until finished.
- Water may leak into the mask if the drink tube slips out of your mouth while the canteen is inverted.
- Disconnect the drink tube from the canteen by blowing into the drink tube while twisting and pulling the coupling from the canteen
- Return the drink tube coupling back into its socket
- Close canteen lid
- Return canteen to carrier
- Replace hood over outlet valve cover (if necessary)



Carefully connect drinking tube.



Invert canteen to drink.



Immediate.



Operational.



Thorough.

Levels of Chemical Decontamination

Ref AFMAN 10-2602

Level	Purpose	Who	What	When	How
Immediate	Minimize casualties, save lives, and help limit contamination exposure and spread	Individuals	Skin, personal clothing and equipment, frequently touched surfaces	As soon as contamination is suspected or detected	M291 and M295
Operational	Limit contamination exposure and spread, helps to sustain operations by providing temporary and, in some cases, long-term relief from wearing IPE	Individuals, crews, teams, units	Parts of essential operational equipment, work areas, vehicles, and material	When operations require and resources permit	M295 and 5% bleach
Thorough	Reduces or eliminates the need for wearing IPE	Units or wings, with or without external support	Personnel (CCA), equipment, material, vehicles, aircraft, work areas, terrain	When required for MOPP reduction; when operations, manning, and resources permit; required for total reconstitution and return to unrestricted use	Contact UCC for guidance

M291 Skin Decontamination Kit

Ref TO 11D1-1-131

Operational Use

- Capable of decontaminating biological and liquid agents from the surface of skin, clothing, masks, gloves, personal equipment, and weapons
- Wallet-sized kit contains six packaged pads containing nontoxic decontaminant
- Proved to be more than 90% effective in removing biological agents from the skin
- Six pads sufficient for three personal decontaminations
- Operates in ranges from -50°F to 120°F

Inspection

- Inspect kit for loose black powder
- If no loose powder present, kit is serviceable
- If powder detected, inspect packets for leaks
- Discard leaking packets
- Replace bad packets
- Reinsert packets into pouch; ensure tear line is at bottom
- Request additional kit if less than four packets
- Use kit until all packets are used



M291 Packets



M291 Pad

M291/M295 Instructions For Use

- Remove decon packet
- Tear open packet and remove decon pad/mitt
- Discard empty packet
- Unfold decon pad/mitt
- M291—Insert fingers into loop
- M295—Grasp non pad side of decon mitt with one gloved hand, insert decontaminated gloved hand into mitt, tighten wristband on glove

MORE

M295 Individual Equipment Decontamination Kit

Ref TO 11D1-3-11-1

Operational Use

- For operational decon and/or self-aid/ buddy care
- Accomplish decon prior to agent sorption (seconds to minutes)
- Used at ground crew CCAs to remove/ minimize contact transfer hazards
- Used for immediate decon of mask, OG, equipment
- Used to decon weapons and tools

M295 Decon Kit Components

- Carrying pouch containing four individual decon packets
- Four packets sufficient for two complete individual equipment decon operations
- Contains four decon mitts filled with decon powder
- Kit is expendable
- Discard packets and pouch after use
- Treat used mitts as contaminated waste

CONTINUED

- Decontaminate individual equipment or exposed skin by rubbing with pad/mitt
- M295—Decontaminate gloved hand that was holding equipment
- Discard pad/mitt
- If more contamination is present, repeat decon with another mitt



M295 Packet.



M295 Mitt.

M291/M295 WARNING

- **Keep decon powder out of eyes, cuts, and wounds**
- **Use water to wash powder out of eyes, cuts, and wounds**
- **Avoid inhalation of decon powder**

Casualty Collection

Ref AFH 36-2218 Vol 1, Vol 2, AFI 10-404

- Casualties are usually moved to a centralized, safe-point for emergency treatment and forwarding, if necessary.
- The casualty collection point (CCP) is staffed as needed by medical and base personnel. The CCP's mission is to evaluate wounded for return to duty, reinforce Self-Aid & Buddy Care (SABC) as needed to stabilize casualties, and/or transport wounded to a deployed medical facility for further care
- When moving casualties, ensure that they are moved feet first or according to SABC
- The CCP may be at the Expeditionary Medical Support Facility, tent, building, an ambulance at a disaster site, or simply a spot on the ground—Shelter is preferable, but not essential
- CCP location and use depends on the contingency operation, threat situation, and available medical and support personnel
- You may be tasked to assist the medical staff at the CCP in casualty care management
- Upon arrival at your deployed location, familiarize yourself with the local casualty care protocols and locations
- Transport human remains to the mortuary—not the CCP



Perform SABC.



Transport casualty to CCP.

Casualty Care in a NBC Contaminated Environment

Ref AFMAN 10-2602

- Place mask on casualty
- Perform SABC measures
- Inject antidote if nerve agent symptoms are present—use casualty's auto-injectors, not yours!
- Report casualty to UCC—DO NOT transmit personal information over unsecure net
- Decon casualty and their equipment with M295 or M291 kits
- Transport casualty to unit CCP
 - Follow route directed by UCC for safe roads and Split-MOPP operations
 - Ambulances do not run during attacks



Use extreme care.

Basic Lifesaving Steps

Ref AFH 36-2218, Vol 1, Vol 2

Use extreme care when treating injuries in a contaminated environment—different rules may apply!



Head tilt, chin lift.

Immediate Steps

When a person is injured:

- Establish an open **Airway**
(If possible neck injury, ensure airway opened using the jaw thrust maneuver, do not turn head)
- Ensure **Breathing**
- Stop bleeding to support **Circulation**
- Prevent further **Disability**
 - Immobilize neck injuries
 - Place dressings over open wound
 - Splint obvious limb deformities
- Minimize further **Exposure** to adverse weather

A Airway
B Breathing
C Circulation
D Disability
E Exposure

Shock

Symptoms:

- Confusion
- Sweaty but cool skin (clammy skin)
- Breathing shallow, labored, and rapid
- Weak and rapid pulse

Treatment:

- Keep airway open
- If unconscious, place on side in recovery position and monitor airway
- Keep the person calm, warm, and comfortable
- Elevate lower extremities
- Seek medical attention immediately
- Do not give food or drink



Elevate lower extremities.



Place organs on abdomen.

Abdominal Wound

Treatment:

- If organs are outside body, gently pick them up and place them on top of abdomen... do not replace or push organs into the body
- Cover exposed organs with moist clean dressing
- Secure with bandages
- If legs are not fractured bend knees to relieve pressure



Secure with bandages.

Always check and treat for shock





Apply direct pressure.



Use pressure points to control bleeding.

Bleeding

Symptom:

- Obvious external bleeding

Treatment:

- Apply direct pressure with hand; use a dressing if available
- Elevate the extremity if no fractures are suspected
- Use pressure points to control bleeding
- Do NOT remove old dressing
- Add more dressing over old if needed

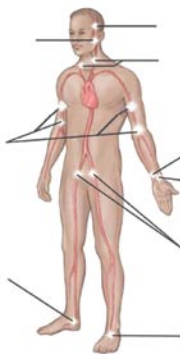

Pressure points.

Tourniquet

Used as the last resort to stop bleeding. Use to save life at possible loss of limb.

- 1 Place one inch wide constricting band around arm or leg to stop severe bleeding
- 2 DO NOT use wire or shoestrings
- 3 Place band 2-4 inches above injury if possible
- 4 Tighten band enough to stop bleeding and no more
- 5 Once in place do not loosen or remove
- 6 Leave tourniquet area exposed for quick visual reference
- 7 Mark time and letter "T" on casualty's forehead (ink or blood)



Use tourniquet as last resort.

Remember—Never remove a tourniquet! Only medical personnel may remove a tourniquet. Never use a tourniquet unless there is danger to life.

Always check and treat for shock



Eye Injury

Symptom:

- Obvious pain or injury

Treatment:

- DO NOT remove any impaled objects
- Dress around object to secure it
- Apply bandage lightly to BOTH eyes
- Do not leave casualty unattended



Cover both eyes.



Make an airtight seal over wound. Tape down three sides.

**Common Injuries**

Ref AFH 36-2218, Vol 1, Vol 2

Chest Wound

Symptoms:

- Sucking noise from chest
- Frothy red blood from wound

Treatment:

- Look for entry and exit wound
- Cover holes with airtight seal (tin foil, ID card)
- Tape down three sides, leave bottom uncovered
- Allow casualty to assume position for easiest breathing, preferably on affected side

**Always check and treat for shock**

Fractures

Symptoms:

- Deformity, bruising
- Tenderness over a specific part of body
- Swelling and discoloration

Treatment:

- DO NOT straighten limb
- If in doubt, splint injury-where they lie if possible
- Splint joints above and below injury
- Remove clothing from injured area
- Remove rings from fingers, if possible
- Check pulse below injury-away from heart to determine if blood flow is restricted



Do not straighten limb.



Maintain immobilization until completely secured.

Spinal/Neck/Head Injury

Symptom:

- Lack of feeling and/or control anywhere below neck, drainage of fluid or blood from ear, nose or mouth

Treatment:

- If conscious, caution casualty not to move
- Continuously monitor and check airway without turning head
- Immobilize the head and neck



If Casualty Must Be Moved

- Use hard surface for litter (door, cut lumber, other)
- Use as many people as needed to place casualty on litter
- One person must immobilize the head and neck
- Ensure casualties' limbs are secured at the chest and thigh regions
- Turn whole body together, as a unit

Do NOT Bend Spinal Cord or Rotate Head and Neck

Combating Heat Illness and Cold Injury

Ref AFMAN 10-2602, AFP 48-151

Your ability to conduct an effective and sustained combat operation depends largely on your ability to avoid heat illness and cold injury. Thermal storage results from your ability to exchange heat between your body and the ambient environment. Thermal related injury can result from a notable rise or fall in your body's core temperature.

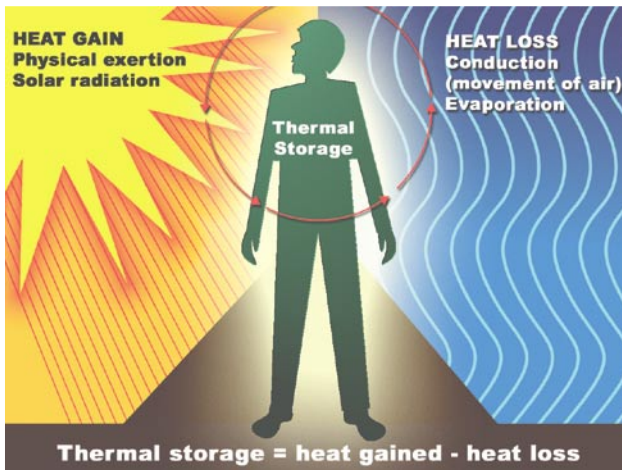

SEE
Page 216,
Quick
Reference,
**Work/rest
Cycles**

You're most prone to heat stress when you wear a Chem/Bio protective overgarment. Regulating thermal storage and fluid intake during an increased OPTEMPO will maximize your ability to fulfill mission requirements. (Water intoxication/over-hydration may mimic the symptoms of heat illness, except high body temperature and dry mouth are usually absent.)

To minimize heat stress and resist heat illness, follow your prescribed work/rest cycle periods and hydration guidelines issued by your unit control center.

In addition to replenishing lost fluids from excessive sweating, it's equally important to increase your food intake to replenish vitamins, minerals, sodium, and calories that are rapidly spent during combat operations.

Dehydration

Ref AFH 32-4005

Symptoms

- Dizzy
- Headache
- Dry mouth
- Skin turgor (skin remains elevated when pinched)

Treatment

- Provide water

Note: If you're urinating, and it's light yellow, that's a good indicator that you're hydrated.



Dizziness, headache.

Heat Exhaustion

Ref AFH 36-2218 V1, V2

Early Symptoms

- Dizziness/weakness
- Headache
- Dry Mouth
- Nausea
- Muscle Cramps
- Spasms, usually in muscles or arms
- Results from strenuous work or exercise
- Loss of salt in the body
- Normal body temperature

Actions

- Remove from work or training
- Allow casualty to rest in shade or cool area
- Provide sips of water
- If symptoms do not improve in 15-30 minutes, transport to medical facility
- If signs or symptoms worsen call ambulance (see immediate actions)



Give sips of water.

Late Signs and Symptoms

- Weak and/or rapid pulse
- Confusion, unresponsive, or coma
- Loss of bowel or bladder control
- Convulsions
- Cramps in abdomen or limbs
- Pale face
- Dizziness/faintness/weakness
- Nausea or vomiting
- Profuse sweating or moist, cool skin
- Weak pulse
- Normal body temperature

Treatment:

- Treat for shock
- Lay person down in cool area
- Loosen/open clothing
- Cool body by sprinkling with cool water or fanning (not to point of shivering)
- Give victim cool water to drink if conscious
- Seek medical attention



Nausea or vomiting.

Always check and treat for shock

Heat Stroke

Ref AFH 36-2218 V1, V2

Symptoms

- Headache
- Dizziness
- Red face/skin
- Hot, dry skin (no sweating)
- Strong, rapid pulse
- High body temperature (hot to touch)

Immediate Actions

- Emergency—call 911/ local number to request medical assistance, or radio for ambulance immediately for transport to the medical treatment area. During combat, transport victim to CCP via unit assets
- Lay person down in shade or cool area with feet elevated, until help arrives
- Give sips of water if casualty is conscious
- If skin is hot and dry to touch, remove clothing; pour water over person and fan. If casualty begins shivering stop fanning process. When shivering stops resume fanning



Give sips of water.



Transport to CCP.

Treatment

- Lay person in cool area
- Loosen/open clothing
- Cool body by sprinkling with cool water or fanning (not to point of shivering)
- Give cool water to drink if conscious—add two teaspoons of salt to one canteen if available
- Seek immediate medical attention
- Treat for shock

Always check and treat for shock



Heat Injuries

Ref AFH 36-2218 V1, V2

Burns

- Burns may be from heat (thermal), electrical, chemical, or radiation. Treatment is based on depth, size, and severity (termed degree of burn)
- Always treat for shock and seek medical advice

Thermal/Partial Thickness (First and Second Degree)

Symptoms:

- Skin reddens (sunburn-like), blisters, painful

Treatment:

- Stop the burning process
- Apply cool water to affected area
- DO NOT break blisters
- Apply clean dry dressing to affected area

Thermal/Full Thickness (Third Degree)

Symptoms:

- Charred or whitish looking skin
- May burn clear to the bone
- Burned area not painful but area around burn very painful

Treatment:

- Stop the burning process
- Do not remove clothing adhered to burned area
- Cover with or apply clean dry dressing to affected area

Electrical Burns

- Ensure power is off
- Look for entry and exit wound
- Treat burned area



First degree burn.



Second degree.



Third degree.

Chemical Burns

- Flush with large amount of water
- Flush eyes for at least 20 minutes
- Brush off visible contaminants
- Keep phosphorous burns covered with a wet dressing (prevents air from activating the phosphorous)
- Fingers have a tendency to swell, ensure that rings/jewelry are removed immediately

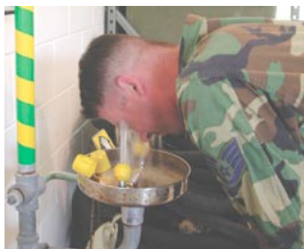

Flush eyes.

Cold Injuries

Ref AFH 36-2118 V1, V2

Hypothermia

Symptoms:

- Body is cold under clothing
- May appear confused
- May appear dead

Treatment:

- Move to a warm place
- Remove wet clothing
- Put on warm clothes or wrap with dry blanket
- Do NOT rub body parts
- Do NOT give or consume alcohol



Wrap casualty in blanket.

Frostbite

Symptoms:

- Skin has white or waxy appearance
- Skin feels hard to touch

Treatment:

- Move to warm place
- Re-warm affected area in warm water 104-108° F (40°C) for 15-30 minutes (NOT hot water)
- Cover with several layers of clothing
- Do NOT rub affected area
- Seek medical attention immediately



Slowly re-warm areas.

SEE
Page 199,
Quick
Reference,
**Wind Chill
Chart**

Emergency Life-Saving Equipment

Ref AFH 36-2118 V1, V2

The key to self-aid and buddy care is improvising when you don't have the equipment you need, use the casualty's gear.



Belts, Ties = Tourniquets, Bandages



Towels, Sheets =
Dressings/Bandages



Shirts = Dressings/Bandages



Socks, Flight cap =
Dressings/Bandages



Expedient equipment.

Sticks or Tree Limbs = Splints





Handling Human Remains

Ref AFI 34-242

Ensure that you treat human remains with dignity. Use the buddy system to transport human remains to a point identified by Mortuary Affairs.

Protect Yourself First

- Wear gloves when handling remains
- DO NOT endanger yourself to retrieve remains
- Wear NBC protective gear if you suspect/confirm the remains are contaminated



Protect yourself first.

Secure Available Identification Information

- DO NOT remove any identification information from remains (dog tags, ID cards)
- DO NOT remove any personal effects from remains (pictures, jewelry, money)



Treat with dignity.

DO NOT Transport to the Casualty Collection Point (CCP)

- Use available transportation and pass information up your chain of command



Use available transportation.

Rights as a Prisoner of War

Ref Geneva Conventions

As a member of a military force, you must understand that you might be captured by a hostile force and held captive as a POW. However, the Third Geneva Convention provides special protections for you in the event you're captured. Your ID card is your Geneva Convention card. Do

not remove the computer chip from CAC ID during combat—the card doesn't contain any information electronically that's not already shown in print.



The Convention States:

- If captured, you may be **disarmed, searched, and guarded** but you must be **humanely treated** without distinction based upon race, color, gender, religious belief, or other arbitrary reason
- As a prisoner, you must **not be humiliated** or degraded and must **be protected** against all acts of violence, insults, public curiosity, and reprisals of all kind
- All prisoners must **be treated alike** with privileges only extended because of poor health, advanced age, military rank, or professional qualifications medical personnel and chaplains are not considered POWs and should be allowed to tend to fellow prisoners. Gender-female POWs must be provided any special care required by their gender



- POWs should be promptly, safely, and humanely evacuated from battle area
- When questioned, you must give your **name, age, rank,** and service number but you do not have to give any other information. Although you may be questioned, you may not be harmed, tortured, or threatened in any way
- As soon as possible, but not later than a week after reaching a POW camp, you must be allowed to send a “**Capture Card**”
- This Geneva Convention postcard informs your next-of-kin of your whereabouts and state of health
- Completion of this card does not violate the Code of Conduct
- POWs, with the exception of officers, may be forced to work
- You may never be forced to do military work or work that is dangerous, unhealthy, or degrading
- You must be paid for all work performed
- Officers may voluntarily work
- NCOs can only be required to perform supervisory work

PRISONER OF WAR MAIL

IMPORTANT
This card must be completed by each prisoner immediately after being taken prisoner and each time his/her address is changed (in reason of transfer to a hospital or to another camp).
This card is distinct from the special card which each prisoner is allowed to send to his/her relatives.

TO: CENTRAL PRISONERS OF WAR AGENCY

CAPTURE CARD FOR PRISONER OF WAR
For use of this form, see AR 100-8, the prisoner agency in DCSPIR.

NAME (Last, First, MI) WRITE LEGIBLY IN BLOCK LETTERS. DO NOT USE ANY PENNIES

SERVICE NUMBER GRADE

DATE OF BIRTH PLACE OF BIRTH

FIRST NAME OF FATHER

NAME, ADDRESS, AND RELATIONSHIP OF NEXT OF KIN

MADEN NAME OF MOTHER

DATE OF CAPTURE OR TRANSFER

PHYSICAL CONDITION (Check appropriate box)

GOOD HEALTH	RECOVERED	SICK	SERIOUSLY WOUNDED
NOT WOUNDED	DISVALUED		SLIGHTLY WOUNDED

FORMER ADDRESS

PRESENT ADDRESS (Name of Camp, or Hospital and Location)

DATE

SIGNATURE OF PRISONER

INTERMENT SERIAL NO.

POW capture card.

Complaints

- The text of the Geneva Convention must be posted in each camp in a language you and all other POWs understand
- You have the right to complain to representatives of a Protecting Power (the neutral State responsible for safeguarding your interests) or to delegates of the International Committee of the Red Cross

Discipline

- Military discipline continues in a POW camp and includes saluting high ranking enemy officers and the camp commander, regardless of rank
- The Uniform Code of Military Justice applies to you while a prisoner
- You must obey the senior US POW regardless of service
- You are **subject to the laws** of the Detaining Power (enemy) for offenses committed during captivity or before capture but not for having fought against the enemy before capture
- If tried by the Detaining Power, you **must be given** notice of the charges, provided counsel and an interpreter, and be allowed to call witnesses in your defense
- If convicted, you still **retain your rights** as a POW



Geneva Conventions identity card.

Medical personnel and chaplains are non-combatants and have certain rights as a result of their status. This card identifies such personnel. In addition to carrying this card, they also wear a distinctive Geneva Conventions armband.

The Code of Conduct

As a member of the US Armed Forces, you are protecting your nation. It is your duty to oppose all enemies of the United States whether in combat or as a captive in a prisoner of war (POW) facility. The Code of Conduct is a guide for your proper behavior. This code is the result of the heroic lives, experiences, and deeds of Americans from the Revolutionary War through our more recent conflicts.

Code of Conduct

- ARTICLE I** I am an American, fighting in the forces which guard my country and our way of life. I am prepared to give up my life in their defense.
- ARTICLE II** I will never surrender of my own free will. If in command, I will never surrender the members of my command while they still have the means to resist.
- ARTICLE III** If I am captured I will continue to resist by all means available. I will make every effort to escape and aid others to escape. I will accept neither parole nor special favors from the enemy.
- ARTICLE IV** If I become a prisoner of war, I will keep faith with my fellow prisoners. I will give no information or take part in any action which might be harmful to my comrades. If I am senior, I will take command. If not, I will obey the lawful order of those appointed over me and will back them up in every way.
- ARTICLE V** When questioned, should I become a prisoner of war, I am required to give name, rank, service number, and date of birth. I will evade answering further questions to the utmost of my ability. I will make no oral or written statements disloyal to my country and its allies or harmful to their cause.
- ARTICLE VI** I will never forget that I am an American, fighting for freedom, responsible for my actions, and dedicated to the principles which made my country free. I will trust in my God and in the United States of America.

JOHN P. JUMPER, General, USAF
Chief of Staff

Section 6

Quick

Reference

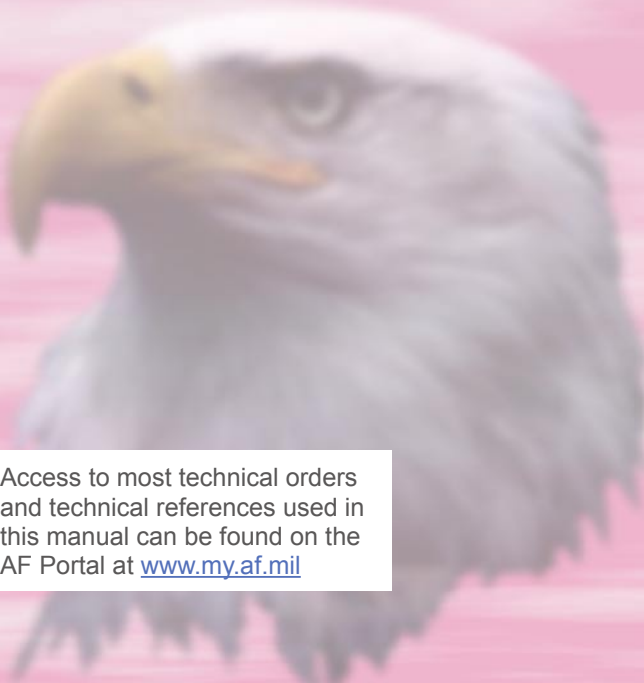

Access to most technical orders and technical references used in this manual can be found on the AF Portal at www.my.af.mil

Accurate communication is essential to effective communication.

Phonetic Alphabet / PROWORDS

Letter	Word	Number	Word	Pronunciation
A	ALPHA	1	ONE	
B	BRAVO	2	TWO	
C	CHARLIE	3	THREE	(TREE)
D	DELTA	4	FOUR	(FOW-er)
E	ECHO	5	FIVE	(FIFE)
F	FOXTROT	6	SIX	
G	GOLF	7	SEVEN	(SEV-en)
H	HOTEL	8	EIGHT	(AIT)
I	INDIA	9	NINE	(NIN-er)
J	JULIET	10	TEN	(TIN)
K	KILO	11	ELEVEN	(E LAV-en)
L	LIMA	12	TWELVE	(TWELL)
M	MIKE	13	THIRTEEN	(THIRD TEEN)
N	NOVEMBER	14	FOURTEEN	(FOR TEEN)
O	OSCAR	15	FIFTEEN	(FIFT TEEN)
P	PAPA	16	SIXTEEN	(SIX TEEN)
Q	QUEBEC	17	SEVENTEEN	(SEV-en TEEN)
R	ROMEO	18	EIGHTEEN	(AIT TEEN)
S	SIERRA	19	NINETEEN	(NIN TEEN)
T	TANGO	20	TWENTY	(TWIN TEE)
U	UNIFORM	30	THIRTY	(THIRD TEE)
V	VICTOR	40	FORTY	(FOUR TEE)
W	WHISKEY	50	FIFTY	(FIFE TEE)
X	XRAY	60	SIXTY	(SIX TEE)
Y	YANKEE	70	SEVENTY	(SEV EN TEE)
Z	ZULU	80	EIGHTY	(AIT TEE)
		90	NINETY	(NIN TEE)
		100	HUNDRED	(HUN DRED)
		1000	THOUSAND	(THAL SUN)
		1,000,000	MILLION	(MIL YEN)

Radio Communications Procedure Words (PROWORDS)

PROWORDS	MEANING
ACKNOWLEDGE	Let me know you received and understood this message.
AFFIRMATIVE	Yes; permission granted; or that is correct.
ALL AFTER	Everything which follows.
BREAK*	Indicates the separation of text from other message portions.
DISREGARD	This transmission is in error—disregard it. NOTE: Don't use this PROWORD to cancel completely transmitted messages.
GO AHEAD	Proceed with your message.
I READ BACK	The following is my response to your instructions to read back.
I SAY AGAIN	I am reporting the transmission or portion indicated.
I SPELL	I shall spell the word phonetically.
NEGATIVE	No; permission is not granted; or that is not correct.
OUT	This is the end of my transmission to you and no answer is required or expected. NOTE: This PROWORD is always preceded by the user's call sign.
OVER*	This is the end of my transmission and a response is necessary. Go ahead and transmit your response. NOTE: This PROWORD is normally used only in tactical communications.
PREPARE TO COPY	This lets the individual receiving your message to prepare to take down the information you are about to pass.
READ BACK*	Repeat all of the specified part of this message back to me exactly as received.

RELAY TO (OR FOR)	Transmit this message to all addresses or to the address designation immediately following this PROWORD.
ROGER	I have received your last transmission satisfactorily.
SAY AGAIN	Repeat all or the following part of your last transmission. NOTE: Never use the word “repeat.” This term is used to place indirect weapons fire onto the enemy.
STAND BY	Wait for further instructions or information.
THAT IS CORRECT	You are correct or what you have transmitted is correct.
THIS IS	The transmission is from whose call sign immediately follows.
UNKNOWN STATION ...	The call sign I am attempting to contact is unknown. NOTE: Previously known as “last calling.”
VERIFY	Confirm entire message (or portion indicated) with the sender. If original message (or portion indicated) is incorrect, send correct version.
Wait*	One must pause for a few seconds.
Wait-out*	Resume communications.
Wilco	Will comply.
Word after*	Word after.
Word before*	Word before.

** For tactical radio transmissions only.*

WIND CHILL CHART

temperature °F

	40	35	30	25	20	15	10	5	0	-5	-10	-15	-20	-25	-30	-35	-40	-45
Calm	40	35	30	25	20	15	10	5	0	-5	-10	-15	-20	-25	-30	-35	-40	-45
5	36	31	25	19	13	7	1	-5	-11	-16	-22	-28	-34	-40	-46	-52	-57	-63
10	34	27	21	15	9	3	-4	-10	-16	-22	-28	-35	-41	-47	-53	-59	-66	-72
15	32	25	19	13	6	0	-7	-13	-19	-26	-32	-39	-45	-51	-58	-64	-71	-77
20	30	24	17	11	4	-2	-9	-15	-22	-29	-35	-42	-48	-55	-61	-68	-74	-81
25	29	23	16	9	3	-4	-11	-17	-24	-31	-37	-44	-51	-58	-64	-71	-78	-84
30	28	22	15	8	1	-5	-12	-19	-26	-33	-39	-46	-53	-60	-67	-73	-80	-87
35	28	21	14	7	0	-7	-14	-21	-27	-34	-41	-48	-55	-62	-69	-76	-82	-89
40	27	20	13	6	-1	-8	-15	-22	-29	-36	-43	-50	-57	-64	-71	-78	-84	-91
45	26	19	12	5	-2	-9	-16	-23	-30	-37	-44	-51	-58	-65	-72	-79	-86	-93
50	26	19	12	4	-3	-10	-17	-24	-31	-38	-45	-52	-60	-67	-74	-81	-88	-95
55	25	18	11	4	-3	-11	-18	-25	-32	-39	-46	-54	-61	-68	-75	-82	-89	-97
60	25	17	10	3	-4	-11	-19	-26	-33	-40	-48	-55	-62	-69	-76	-84	-91	-98

wind (mph)

Frostbite occurs in 15 minutes or less!

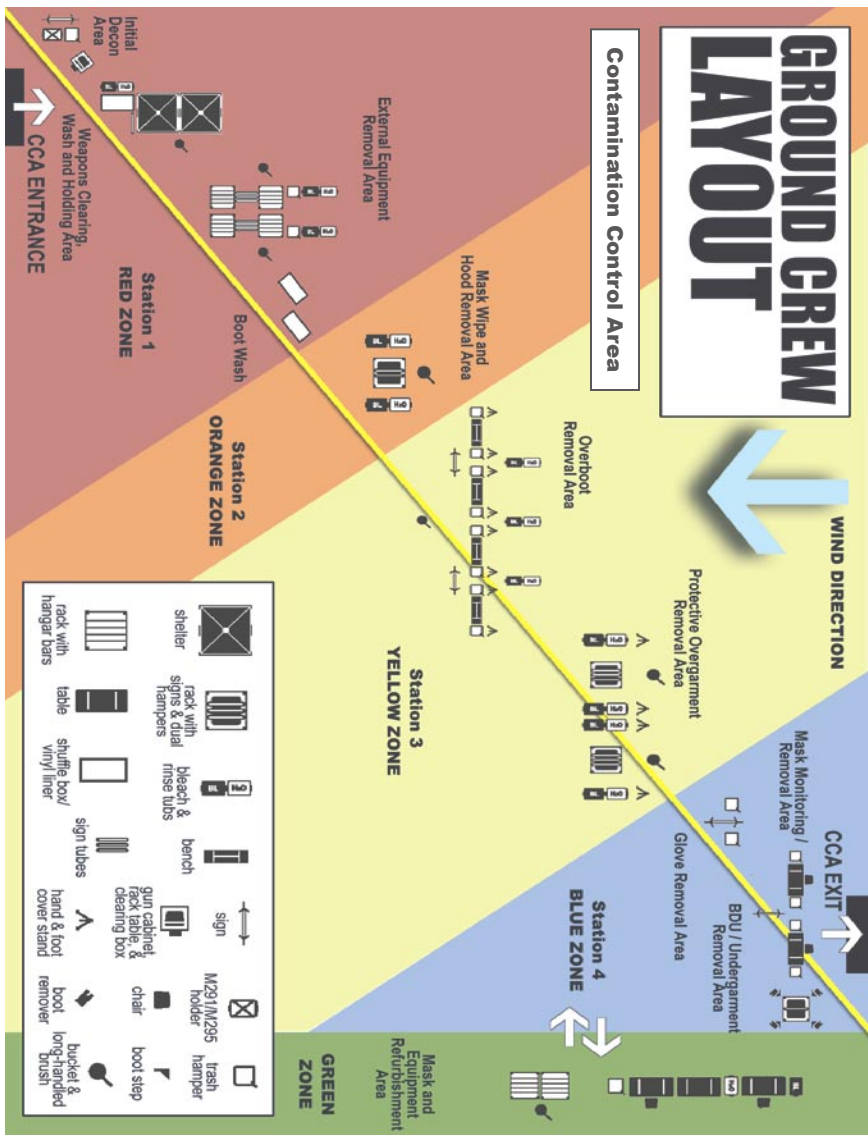

Nuclear, Biological, and Chemical (NBC) and Unexploded Ordnance (UXO) Hazard Markers

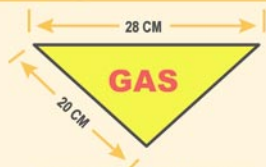

CHEMICAL
yellow background
with red lettering

Name of Agent (if known)
Date and Time of Detection



BIOLOGICAL
blue background
with red lettering

Name of Agent (if known)
Date and Time of Detection



RADIOLOGICAL
white background
with black lettering

Dose Rate
Date and Time of Reading
Date and Time of Burst (if known)

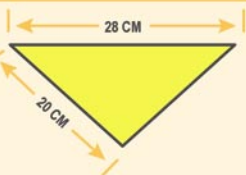

Back Surface of Marker
Facing Contamination



UNEXPLODED ORDNANCE
red background
with white lettering

Type and Date Found
Front Surface of Marker
Facing Away from UXO



Back Surface of Marker
Facing UXO



**MINEFIELD
(UNEXPLODED MINES)**
red background
with white lettering

Date of Emplacement
Front Surface of Marker
Facing Away from Minefield



Back Surface of Marker
Facing Minefield

DANGER BOMB  **DANGER UXO**

Expedient Nuclear, Biological, Chemical, and Conventional (NBCC) Hazard Markers

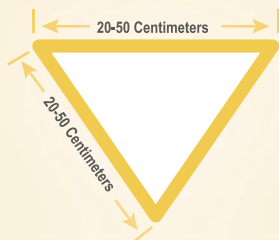

Construct Expedient Markers to the Approximate Size and Shape Shown

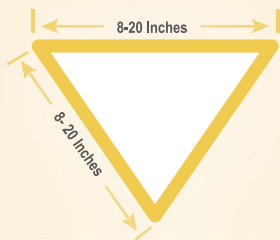

CHEMICAL
letter "G" inside

Use Expedient Markers When Standard Markers are Unavailable



BIOLOGICAL
letter "B" inside



RADIOLOGICAL
letter "A" inside

Write Date and Time of Discovery and Hazard Information on the Marker with an Indelible Marker



UNEXPLODED ORDNANCE
letter "U" inside

USE ANY SUITABLE MATERIAL TO CONSTRUCT EXPEDIENT MARKERS

The 10-Foot Rule is a risk management philosophy involving procedures that enable wing commanders to increase operational capability with an increased degree of risk. It addresses the potential presence of residual chemical contamination originating from relatively non-porous equipment surfaces such as bare metal and glass. *Ref AFMAN 10-2602*

24-Hour Initial Phase



Personnel will remain in MOPP Level 4 whenever they stay within 10 feet of the contaminated equipment for more than a few seconds during the initial 24-hours after a chemical attack.

Follow-on Phase



After initial phase (24-hours) and when directed by commander, personnel will use gloves of any sort (i.e., leather, rubber, cloth, etc.) when operating on or handling the contaminated equipment.

Improvised Explosive Device Reporting and Evacuation

Follow the 4-R's used for UXO reporting procedures to report an IED (Recognize, Record, Retreat, Report) and evacuate the area (if possible) using the distances shown here as a guideline.

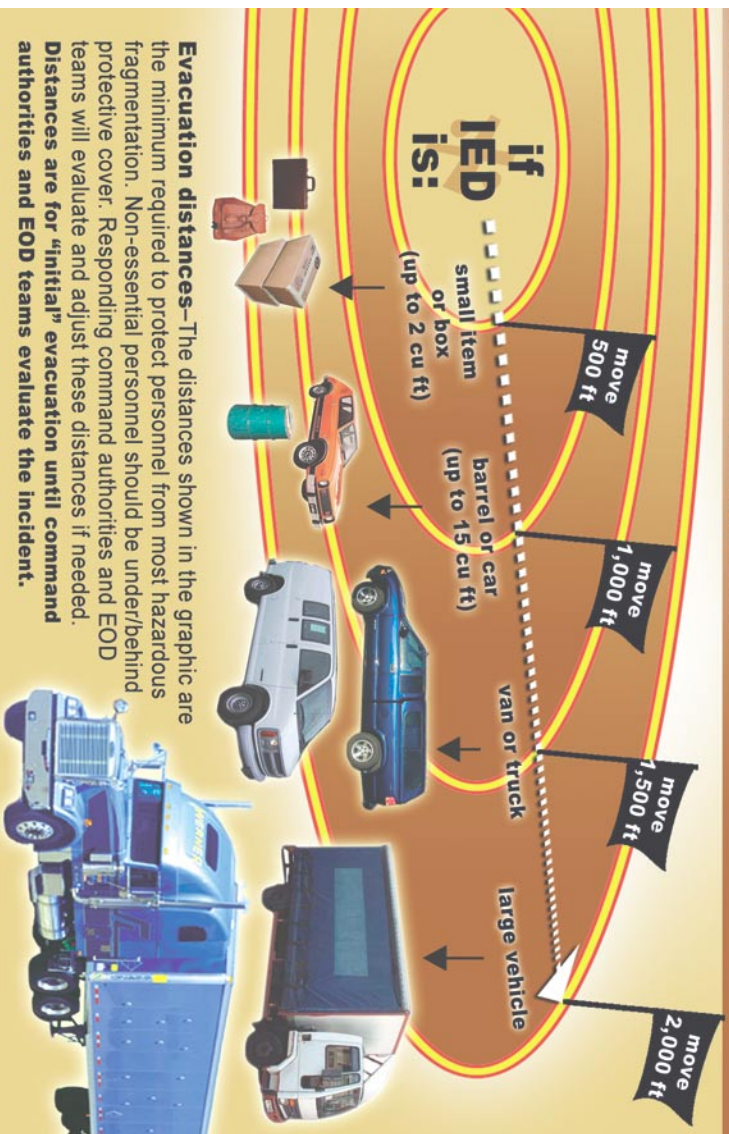

Evacuation distances—The distances shown in the graphic are the minimum required to protect personnel from most hazardous fragmentation. Non-essential personnel should be under/behind protective cover. Responding command authorities and EOD teams will evaluate and adjust these distances if needed. Distances are for “initial” evacuation until command authorities and EOD teams evaluate the incident.

MCU-2 Series Mask Inspection *Ref 14P4-15-1*

ITEM	INSPECT FOR	CORRECTIVE ACTION
Facepiece	Cracks, tears, or deterioration and separation between silicone, rubber, and the metal parts.	Condemn Mask
Face seal	Cracks or tears. Run finger over seal to inspect for nicks or surface irregularities. Face seal must be soft, smooth, and pliable.	Condemn Mask
Forehead, Temple, and Neck Tabs	Nicks or rips, along edges, or where buckles connect. Run a finger around edges to check for discrepancies.	Condemn Mask
Buckles	Bends, cracks or looseness where molded into the facepiece tabs. Pull on head harness straps. Make sure the buckles hold the strap tight.	Condemn Mask
Head Harness or Skull Cap	Tears, surface dirt, or mildew. Pull straps to make sure they have not lost their elasticity.	Replace if straps are torn, broken, or have lost their elasticity.
Side Voicemitter Retaining Ring	Corrosion or looseness.	Replace if corroded. Tighten if loose.
Side Voicemitter	Dents, punctures, or cracks. The four pins in the center face toward the outside of mask.	Replace if dented, punctured, or cracked. Remove and correctly reinstall if four pins are not facing outwards.
Side Voicemitter Gasket	Cracks and cuts	Install a new side voicemitter gasket, if unserviceable, (e.g. cut, distorted or damaged)
Front Voicemitter Retaining Ring	Tightness using the tips of two fingers on the flat part of the ring	Repair mask
WARNING: Do not attempt in any way to loosen front voicemitter ring during check for tightness.		
Front Voicemitter	Punctures or cracks. (Damaged microphone connector assembly MCU-2 Series).	Repair mask
Outlet Valve Cover	Cracks, rips and general cleanliness inside and out.	Replace if cracked, ripped or if it will not seat firmly on outlet valve body. Wipe away any dirt or moisture on cover with a soft, dry, clean cloth
Outlet Valve Disc and Valve Disc Body	Curls, nicks, rips, dirt or moisture. Turn disc to make sure it is not stuck to valve seat. Make sure outlet valve disc with supportive screen has been installed. Push cover back on outlet valve. Make sure cover is seated firmly.	Replace if curled, nicked, ripped, cannot be cleaned, or will not seat properly. Replace outlet valve disc with supportive screen, if required. Wipe away any dirt or moisture with a soft, dry, clean cloth.
Disbonding	Lift nose cup from around flange of the outlet valve assembly. Check for disbonding of silicone facepiece to metal outlet valve assembly.	Condemn mask if disbonding has occurred.

Nosecup	Cracks or cuts, and that it is seated in outlet valve flange and securely held around the front voicemitter.	Condemn Mask if the nosecup is cracked, cut or loose at the voicemitter. If nosecup is not sealed around the outlet valve flange, push the nosecup back over the flange.
Valve Disc	Inspect for proper installation of valve seat or separation from the nosecup. Make sure valve discs are not cut or torn. Turn the disc with the tip of finger to make sure disc are not stuck on valve seats.	Replace valve discs that are curled, or torn.
External Drinking Tube	Cracked, cut or deteriorated rubber. Dented or cracked coupling. Loose on feed through pipe or at metal coupling. Check for stuck valve by performing drink tube leak check	Replace
Internal Drinking Tube	Cracks, cuts, and to see if it is lose on the feed-through pipe	Replace if cracked, cut or loose
Drink Tube Assembly	Perform drink tube leak test	Replace if required
Inlet Valve Disc	Curls or tears. Turn disc to make sure it is not stuck to valve seat. Make sure disc is properly installed on Air Deflector Post	Replace if curled or torn, install valve disc behind valve disc retaining ring.
Lens	Punctured lens. Stains or scratches that prevents normal vision. Any separation between the mask lens and facepiece	Condemn Mask
Canister	Cracks, dents, or holes around the seams, dirt clogging the air intake and for damaged threads. Any signs of loose particles in filter when shaken	Replace if cracked or dented on a seam, dented deeper than a 1/4 inch, if it has holes, threads are damaged, or air intake is clogged with dirt. Replace filter if signs of loose particles are present.
Protective Hood	More than 2 pinholes in any one panel. Rips, tears, or if rubber coating is sticky or scuffed off	Replace hood
Carrier	Cleanliness, damage, excessive wear, missing straps or fasteners	Repair if possible or replace
Waterproofing bag	Damage	Replace if required
Outsert	Stains or scratches that prevents normal vision. Cracks, missing clips, or rubber straps	Replace the rubber strap if broken or missing.
Front Voicemitter/Micmitter Assembly	Broken, missing, damaged, loose, corroded, dirty, etc.	Repair mask
Body, Inlet Valve	Cracks, tears or deterioration, surface irregularities and dirt	Clean if dirty, replace if worn or cracked.

M45 Mask Inspection *Ref 14P4-18-1*

ITEM	PROCEDURE	NOT FULLY MISSION CAPABLE IF:
Canister	Check that canister is securely attached to facepiece.	Filter canister cannot be securely attached to the facepiece.
Mask	Run finger under inner lip to make sure folded material doesn't stick together.	Inside surfaces are damaged or cannot be separated.
Internal Drink Tube and Microphone Assembly	Check that internal drink tube and microphone assembly (if issued) are present and securely attached to outlet valve housings.	Internal drink tube or microphone assembly are missing or loose
Nosecup Assembly	<ol style="list-style-type: none"> Check that nosecup is attached to front voicemitter and outlet valve housing. Run finger along inner lip of nosecup to ensure it is not sticking. Check that nosecup is not stuck to inside of facepiece. Check that nosecup valve disks are present and seated on nosecup valve seats, rotate discs to be sure they are not stuck, curled, or torn. 	<ol style="list-style-type: none"> Nosecup is pulled away from voicemitter/outlet valve housing. Inside surfaces are damaged or cannot be separated. Nosecup cannot be separated from facepiece. Nosecup valve disks are missing or not seated on valve of nosecup valve seats. Disks are stuck, curled, or torn.
Inlet Valve Assembly	<ol style="list-style-type: none"> Fold back left side of nosecup to fully expose inlet valve assembly. Check that inlet valve disk is present and positions in the slot on the cage and post assembly. Check cage for cracks. Check inlet valve disk for tears and curls. Make sure disk lies flat Rotate inlet valve disk and cage and post assembly with finger. Make sure it lies flat and doesn't stick. 	<ol style="list-style-type: none"> Inlet valve disk is missing or not positioned on the cage and post assembly. Cage is cracked, missing or not positioned on inlet valve gasket. Inlet valve disk has cuts, tears, curls or does not seal against inlet valve gasket. Inlet valve sticks.
Vision Correction Inserts	Ensure inserts are attached to facepiece (if issued.)	Inserts will not attach to facepiece.
Outserts	Check that outserts are installed and securely attached to facepiece.	Outserts are missing or will not attach securely to facepiece.
Microphone Cable	Check to see that microphone cable is attached securely to the receptacle on the facepiece (if issued.)	Microphone cable cannot be attached securely to facepiece, or cable is cut or cracked.
Second Skin	Check that second skin is present and properly installed.	Second skin is missing or installed incorrectly.
Outlet Valve Disk and Outlet Valve Cover	<ol style="list-style-type: none"> Grasp tab, pull and stretch bottom portion of outlet valve cover over the barb. Check that outlet valve disk is present and not curled, distorted, or dirty. With finger, rotate outlet valve disk to ensure it is not sticking. Replace outlet valve cover. 	<ol style="list-style-type: none"> Outlet valve disk is missing, curled, distorted, or dirty. Outlet valve disk is sticking and cannot be rotated.

External Drink Tube	Check that external drink tube is present and securely attached.	External drink tube is missing or loose.
Waterproof Bag	a. Check waterproof bag for cracks, tears, holes or brittleness. b. Check that rubber bands are in bag and are not sticky, broken or brittle.	a. Waterproof bag is torn, has holes, or is brittle. b. Rubber bands are missing, or are sticky, broken, or brittle.
Mask	Don mask and check mask for leaks.	Mask leaks

ITEM	PROCEDURE	NOT FULLY MISSION CAPABLE IF:
Canister	a. Check canister intake for clogs. b. Check canister replacement criteria.	a. Canister intake is clogged. b. Canister is expired.
Microphone Cable	a. Check microphone cable for cuts, cracks and bent pins (if issued.) b. Check that microphone cable is attached to the receptacle in the facepiece.	a. Microphone cable is cut, cracked or has bent pins. b. Microphone cable will not securely attach to the facepiece.
Second Skin	Inspect second skin for cracks, tears, and splits.	Second skin is cracked, torn or split.
External Drink Tube	a. Check external drink tube for cuts, cracks or holes. b. Check external drink tube for tight connection to the outlet valve housing and quick disconnect coupling.	a. External drink tube is missing, or has cuts, cracks or holes. b. External drink tube connection to outlet valve housing or quick disconnect coupling is loose.
Outlet Valve Disk and Outlet Valve Cover	a. Grasp tab, pull and lift bottom of outlet valve cover over barb. Check cover for cuts, holes, and tears. b. Check that outlet valve disk is seated and not curled, torn, dirty, punctured, or distorted. Rotate disk to ensure it is not sticking. c. Wipe moisture from outlet valve and seat with cheesecloth. d. Check outlet valve seat for dirt, nicks, or cracks. Smooth outlet valve disk so it lies flat on seat. e. Check that barb is not broken or cracked. f. Wipe moisture and dirt from outlet valve cover with cheesecloth and check for cuts, tears or holes. Reinstall cover.	a. Outlet valve cover is cut, torn, or punctured. b. Outlet valve disk is curled, sticking, punctured, dirty, distorted, torn, or will not seat. c. Outlet valve disk or seat cannot be cleaned. d. Outlet valve seat is nicked or cracked, or disk will not seat properly. e. Barb is cracked or broken. f. Outlet valve cover is cut, torn, has holes, or will not seat firmly over outlet valve.
<p>WARNING: Do not use paper to remove moisture from outlet valve cover, outlet valve disk, or outlet valve seat. Paper may break up and lodge in outlet valve area causing leakage.</p>		

continued... M45 Mask Inspection Ref 14P4-18-1

ITEM	PROCEDURE	NOT FULLY MISSION CAPABLE IF:
Voicemitters	Check front and side voicemitters for dirt, cracks, punctures or obstructions.	Voicemitters are dirty or damaged.
Head Harness	<ol style="list-style-type: none"> Check buckles for bends, cracks, or corrosion. Pull on head harness straps to ensure buckles hold straps. Put on facepiece and check head harness for loss of elasticity. Check for dirt. Check each strap for cuts, tears, missing parts or deterioration such as mildew or fraying. 	<ol style="list-style-type: none"> Buckles are missing, broken, or will not hold straps. Head harness will not hold mask firmly against face. Head harness is dirty, cut, torn, frayed, has missing parts or is deteriorated.
Facepiece	Inspect facepiece for dirt, holes, tears and splits. Look closely at the inside of the facepiece where it touches your skin.	Mask has holes, tears, splits, or soft spots that allow air to enter.
Internal Drink Tube	<ol style="list-style-type: none"> Check internal drink tube for cuts, cracks or holes. Ensure that internal drink tube opening is oriented so you can drink with the mask on. 	<ol style="list-style-type: none"> Internal drink tube has cuts, cracks or holes. Internal drink tube is oriented so that you cannot grasp it with your mouth.
Inlet Valve Assembly	<ol style="list-style-type: none"> Fold back left side of nosecup to fully expose inlet valve assembly. Check that inlet valve disk is present and properly positioned on cage and post assembly. Check inlet valve disk for tears, curls or dirt. Make sure inlet valve disk lies flat. From outside the mask, blow on inlet valve disk to ensure it isn't sticking. Check inlet valve cage and post assembly for distortion. 	<ol style="list-style-type: none"> Inlet valve disk is missing or not positioned on the cage and post assembly. Inlet valve disk has tears, curls, or does not seat against inlet valve gasket. Inlet valve disk sticks. Inlet valve cage and post is damaged or won't rotate freely.
Nosecup	<ol style="list-style-type: none"> Check that nosecup is not pulled away from back of outlet valve housing and front voicemitter. Check that nosecup and nosecup valve seats are free of dirt. Check nosecup for cracks, cuts, tears and holes. Look at inside of nosecup inner lip where it touches your skin. Rotate nosecup valve disks to ensure they are not sticking. Check that valve disks are not dirty, curled or torn. 	<ol style="list-style-type: none"> Nosecup is pulled away from back of outlet valve housing and front voicemitter. Nosecup is dirty, cracked, cut or has holes. Nosecup valve seats are dirty. Nosecup valve disks are torn, missing, dirty, or stuck to nosecup.

AFTER USE

Vision Correction Inserts

Inspect vision correction inserts (if issued) for loose or broken lenses, and frames that will not attach to facepiece.

Loose, broken or missing lens or frame. Insert frame disconnected from facepiece.

Outserts, Eyelens and Eyerings

- a. Remove outserts by grasping tab and pulling away from mask. Check outserts for cracks, scratches or discoloration that affects vision.
- b. Check eyelens for cracks, scratches, dirt or stains that affect vision
- c. Check eyerings for cracks. Install outserts onto eyerings by snapping front edge into place first.

- a. Outserts are broken, distorted, or discolored.
- b. Eyelenses are cracked, scratched or stained enough to affect vision.
- c. Eyerings are cracked.

Carrier

- a. Empty carrier and check for dirt, tears, holes or missing buckles, d-rings, straps, strap hooks and hardware. Check seams for broken stitches.
- b. Ensure hook and pile fasteners hold carrier flap securely. Stow your mask.

- a. Carrier is torn, seam stitching is loose, or buckles, d-rings, straps, or strap hooks are missing.
- b. Carrier flap will not stay closed.

Serviceable Tag-Materiel, DD Form 1574

Front

- Stock number
- Mask type
- Size
- Mask lot number
- Inspection activity
- Inspector's name and date
- Fill-in remarks section when serviceable C2 series canister is installed
 - Canister lot number
 - Date canister installed
 - TDA99M or JSMLT certified MMY

Masks will be cleaned and inspected:

- Upon issue and every six months after initial issue date during peacetime
- Prior to deployment and every seven days during contingency operations.
- Before long term storage (30 days or more)
- Prior to turn-in to supply
- After completion of each training contingency/exercise







Rear

- Date inspected
- Inspected by
- Next inspection due date

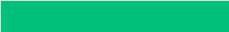
Stock Numbers

MCU-2P	Size	MCU-2A/P	Size	M45
4240-01-497-7120	S	4240-01-284-3615		
4240-01-497-7124	M	4240-01-284-3616	XS	4240-01-447-6989
4240-01-497-7128	L	4240-01-284-3617	L	4240-01-447-6988

CONTROL TOWER LIGHT SIGNALS

SIGNAL	FOR AIRCRAFT	FOR VEHICLES
steady green 	cleared to land cleared for takeoff	cleared to cross
flashing green 	return for landing cleared to taxi	not applicable
steady red 	give way to aircraft STOP	STOP
flashing red 	airport unsafe clear runway	clear runway
flashing white 	return to starting point on airport	
alternating red and green 	general warning signal exercise extreme caution	

AFVA 13-221, 1 November 2001

Distribution: F

Prescribed by AFI 13-203

Battle Dress Overgarment (BDO) and Chemical Protective Overgarment (CPO) and Accessory Inspection Checklist *Ref TO 14P3-1-141*

Caution: Do not remove overgarments (OG) from factory vacuum-sealed bags specifically for inspection.

ITEM	INSPECT FOR	CORRECTIVE ACTION
BDO/CPO Factory Bag	<ul style="list-style-type: none"> a. General Cleanliness b. Holes or tears c. Loss of vacuum seal (puffy bag) d. Labels 	<ul style="list-style-type: none"> a. If dirty, wipe clean. b. If present, inspect visible fabric under hole or tear for damage and cleanliness. If undamaged and clean, seal hole or tear with high quality adhesive tape (e.g. common duct tape). When taping of the factory bag is impractical, place the BDO in the original factory bag, in a clear plastic bag and seal with tape. c. Tests have shown that loss of vacuum seal alone does not impact OG serviceability. Inspect for holes, tears, etc., if found, repair. d. Packages that have surveillance information labels in danger of falling off, remove the outer clear plastic bag and using an indelible marker, clearly print on the nylon foil package at a minimum, the following information: Contract number, last four digits of NSN, manufacture date, surveillance marking number and the garment size. Reseal foil package in the outer clear plastic bag.
Coat and Trouser	<ul style="list-style-type: none"> a. Signs of wetting (i.e. stains, deterioration, etc.) b. Holes or tears c. Cleanliness d. Fasteners proper operation e. Shelf life manufactured date 	<ul style="list-style-type: none"> a. If present, condemn the item. Use for training or dispose of it b. If present, Use for training or dispose of it c. If dirty, wipe clean with a dry cloth d. BDO with broken or torn fasteners that cannot be secured, will be condemned. Use for training or dispose of it e. If expired, condemn the BDO. Use for training or dispose of it
Protective Gloves	<ul style="list-style-type: none"> a. Factory bag cleanliness b. Holes or tears c. Glove material dry rot, brittleness, holes or tears d. Shelf life/manufacture date 	<ul style="list-style-type: none"> a. If dirty, wipe clean b. If present, inspect glove material c. If present, condemn the item. Use for training or dispose of it d. If expired, condemn the item. Use for training or dispose of it

Glove Inserts	<ul style="list-style-type: none"> a. Factory bag cleanliness b. Holes or tears c. Cotton material condition 	<ul style="list-style-type: none"> a. If dirty, wipe clean b. If present, inspect cotton material c. Dispose of inserts which are damaged to the point where they cannot be comfortably worn
Footwear cover	<ul style="list-style-type: none"> a. Factory bag cleanliness b. Factory Bag holes or tears c. Footwear cover material dry rot, brittleness, holes or tears d. Footwear cover material oily residue ("slimed" overboot) on unopened/ unused overboots e. Laces and elastic fasteners (GVO/ BVO) breaks f. Shelf life manufacture date 	<ul style="list-style-type: none"> a. If dirty, wipe clean. b. If present, inspect footwear cover material and laces. c. If present, condemn the item. Use for training or dispose of it. d. If present, suspend the item. Submit a product deficiency report IAW AFTO 00-35D-54. DSCP will authorize one-for-one replacement. e. Replace the laces or elastic fasteners. f. If expired condemn the item. Use for training or dispose of it.



Quick MOPP

MOPP Level	Field Gear	Clothing	Footwear	Mask/Hood	Handwear
0	Worn	Carried	Carried	Carried	Carried
1	Worn	Worn	Carried	Carried	Carried
2	Worn	Worn	Worn	Carried	Carried
3	Worn	Worn	Worn	Worn	Carried
4	Worn	Worn	Worn	Worn	Worn

Work Rest Cycles and Fluid Replacement Guidelines

Heat Category	WBGT ¹ Index (°F)	Light (Easy) Work		Moderate Work		Hard (Heavy) Work	
		Work/Rest ²	Water Intake ³ (Qt/Hour)	Work/Rest ²	Water Intake ³ (Qt/Hour)	Work/Rest ²	Water Intake ³ (Qt/Hour)
1	78-81.9	NL ⁴	1/2	NL	3/4	40/20 min	3/4
2	82-84.9	NL	1/2	50/10min	3/4	30/30 min	1
3	85-87.9	NL	3/4	40/20min	3/4	30/30min	1
4	88-89.9	NL	3/4	30/30min	3/4	20/40min	1
5	>90	50/10mm	1	20/40min	1	10/50min	1

Notes:

1. If wearing MOPP Level 4, add 10°F to Wet Bulb Globe Temperature (WBGT). If wearing personal body armor in humid climates, add 5°F to WBGT.
2. Rest means minimal physical activity (sitting or standing), accomplished in shade if possible.
3. *Caution:* Daily fluid intake should not exceed 12 quarts. Hourly fluid intake should not exceed 1 quart. The work/rest time and fluid replacement volumes will sustain performance and hydration for at least 4 hours of work in the specified work category. Individual water needs will vary = 1/4 quart hour.
4. NL = no limit to work time per hour.

Work Intensities of Military Tasks

Light (Easy) Work

- Weapons maintenance
- Walking on hard surface at 2.5 mph, with <30 pound load
- Marksmanship training
- Tower operations
- Operations NCOs/officers
- Pilot ground activities
- Command post and unit control center activities

Moderate Work

- Walking on loose sand at 2.5 mph, with no load
- Walking on hard surface at 3.5 mph <40 pound load
- Calisthenics
- Patrolling
- Individual movement techniques such as low/high crawl
- Refueling
- Avionics shop
- Aircraft maintenance
- Unit post attack reconnaissance

Heavy (Hard) Work

- Walking on hard surface at 3.5 mph, with >40 pound load
- Walking on loose sand at 2.5 mph, with any load
- Armament crew
- Heavy aircraft repair
- Specialized teams such as NBC reconnaissance, search and recovery, rapid runway repair, CCA, fire protection, decontamination, medical, damage assessment and repair, and EOD

Square Grid Matrix

Outside border letter/number combinations
identify anticipated response symbol

Given
E2 or 2E.
Answer = T

	1	2	3	4	5	6	7	8	
H	M	I	K	E	S	M	I	T	H
G	R	7	4	B	L	8	3	A	G
F	H	S	9	3	Q	E	7	4	F
E	S	T	E	V	E	P	R	I	E
D	2	J	7	S	4	Y	B	8	D
C	D	P	2	H	9	C	K	S	C
B	X	K	9	R	3	N	T	7	B
A	F	A	S	T	2	4	0	Z	A
	1	2	3	4	5	6	7	8	

Given
D8 or 8D.
Answer = 8

Very secure method that's often used during
MOPP conditions when visual identity is
difficult

Reading a Grid Map Ref AFJMAN 24-306

- Grid maps help you find and report locations
- Grid maps contain intersecting horizontal and vertical lines that form square box grids
- Grid numbers run left-to-right
- Grid letters run bottom-to-top
- The combined grid number and letter is the grid coordinate
- Grid maps are read “right-up”
- **This is grid coordinate 2-B**
- Identify grids using a number and letter combination (in that order)
- Write it as shown here or say grid coordinate “two, bravo”

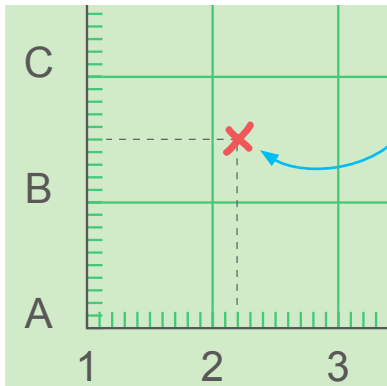
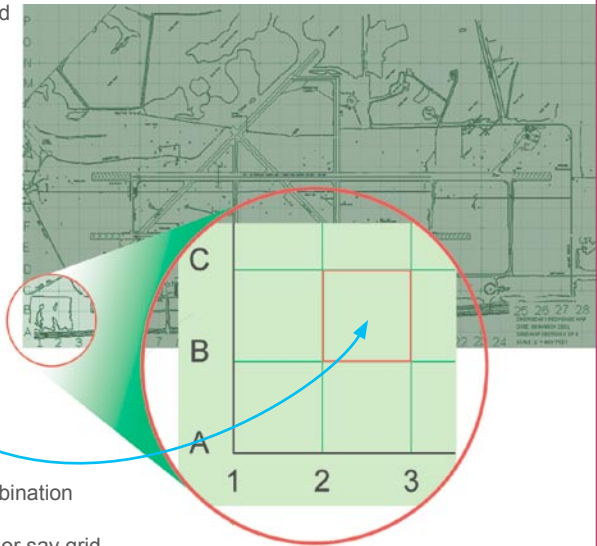

- For improved accuracy, grid squares are further subdivided into 10 evenly spaced blocks
- **This example shows grid coordinate 2.2-B.5**
- Write it as shown here or say grid coordinate “two point two - bravo point five”

NOTE: Sub-blocks may or may not be marked on your map. If they're not, use your best judgment to identify the coordinate you want to plot within a grid square.

Chemical Warfare: Four Major Categories of Agents

Ref PACAF C-CW CONOPS Technical Report, Nov 2000

Category	Agent	General Symptoms	Personal Protection
<p><i>Nerve and Blister agents present the most significant hazards to an airbase because of their high toxicity at low-levels of exposure.</i></p>			
Nerve	VX GA (Tabun) GB (Sarin) GD (Soman) GF (Cylcosarin)	Designed to attack the nervous system—runny nose, tightness of the chest, breathing difficulty, eye pain, dimness of vision, pinpointing of pupils, drooling, excessive sweating, nausea, vomiting, diarrhea, cramps, twitching of large muscle groups, headache, confusion, drowsiness, involuntary defecation and urination, cessation of breathing, loss of consciousness, coma and death.	MOPP-4 when operating in proximity of either a liquid or vapor hazard. All clothing should be immediately decontaminated after coming into contact with liquid agent.
Blister	H & HD (Distilled Mustard) L (Lewisite) CX (Phosgene Oxime)	Primary hazard is to incapacitate, but it can be lethal in high enough doses—tearing, conjunctivitis, ulceration of exposed eye surfaces, lung inflammation accompanied by fluid accumulation in irritated tissues, impairment of respiratory gas exchange, blistering action on the skin.	MOPP-4 when operating in proximity of either a liquid or vapor hazard. All clothing should be immediately decontaminated after coming into contact with liquid agent.
<p><i>Blood and Choking agents do not produce long-term threats to an air base. However, unprotected exposure to high enough quantities of these agents can cause death.</i></p>			
Blood	AC (Hydrogen Cyanide) CK (Cyanogen Chloride) SA (Arsine)	Headache, dizziness, and nausea, which can progress to coma, convulsions, and cessation of breathing.	MOPP-4 when operating in proximity of either a liquid or vapor hazard.
Choking	CG (Phosgene) DP (Diphosgene)	Coughing, choking, and tightness of the chest as well as occasional nausea, vomiting, headache, and tearing. Difficulty in breathing and a diminished lung oxygen exchange become evident as fluids accumulate in lungs.	MOPP-4 when operating in proximity of either a liquid or vapor hazard.

Acronyms and Definitions Used in This Manual

°C	Degrees Celsius (Temperature)
°F	Degrees Fahrenheit (Temperature)
<	Less Than
=	Equal To
>	Greater Than
2-Pam Chloride	Pralidoxime (Nerve Agent Antidote)
4-R's	Recognize, Record, Retreat, Report
463L	Type of Aircraft Cargo Pallet
AFOSI	Air Force Office of Special Investigations (Also OSI)
Alarm Blue	Equivalent to Alarm Red in Korea
Ambulatory	Walk Under Own Power
Atropine	Nerve Agent Antidote
BDO	Battle Dress Overgarment
BDU	Battle Dress Uniform
Bio	Biological
BVO	Black Vinyl Overboots
C2 Series	C2 Series Canister (Filter)
CAC	Common Access Card (Military ID Card)
Camo	Camouflage
CB	Chemical, Biological
CBRN	Chemical, Biological, Radiological, Nuclear
CBRNE	Chemical, Biological, Radiological, Nuclear, and high-yield Explosive
CCA	Contamination Control Area
CCP	Casualty Collection Point
CE	Civil Engineer
CHA	Contact Hazard Area
Chem/Bio	Chemical, Biological
COA	Course of Action
COMSEC	Communications Security
CONOPS	Concept of Operations
CONUS	Continental United States (US Mainland)
CPO	Chemical Protective Overgarment, previously called Joint Service Lightweight Integrated Suit Technology (JSLIST)
DC	Defense Council
Decon	Decontaminate or Decontamination
De-energize	Shut-off
DEET	N, N-diethyl-meta-toluamide (insect repellent)
DFP	Defensive Fighting Position
Diazepam	Nerve Agent Antidote

DoD	Department of Defense
DU	Depleted Uranium (Heavy Dense Radioactive Material)
EMP	Electromagnetic Pulse (Nuclear Blast Effect)
EOC	Expeditionary Operations Center
EOD	Explosives Ordnance Disposal
EPW	Enemy Prisoner of War
FDA	(United States) Food and Drug Administration
FPCON	Force Protection Condition
Ft, ft	Foot or Feet
GTC	Government Travel Card
GVO	Green Vinyl Overboots
HAZMAT	Hazardous Material
Hr, hr	Hour
HVAC	Heating, Ventilation, Air Conditioning
Hydrate	Drink or Add Liquid
IBD	Integrated Base Defense
IED	Improvised Explosive Device
In, in	Inch or Inches
IPE	Individual Protective Equipment
JA	Judge Advocate
JFIRE	Joint Firefighters Protective Overgarment
JSLIST	Joint Service Lightweight Integrated Suit Technology now called CPO
Km, km	Kilometer or Kilometers
LES	Leave and Earnings Statement
LOAC	Law of Armed Conflict
M, m	Meter or Meters
M291	Skin Decontamination Kit
M295	Individual Equipment Decontamination Kit
M45	M45 Land Warrior Chemical-Biological Mask
M8	M8 Chemical Detector Paper
M9	M9 Chemical Detector Paper
Mark 1 kit	Nerve Agent Antidote Kit (NAAK)
MCU-2 Series	MCU-2P or MCU-2A/P Mask
Mi, mi	Mile or Miles
Min, min	Minute or Minutes
MOPP Ready	Joint Service Term Equivalent to USAF MOPP Level 0
MOPP	Mission Oriented Protective Posture
MPF	Military Personnel Flight
MRE	Meals Ready to Eat
MULO	Multipurpose Lightweight Overboots
NAAK	Nerve Agent Antidote Kit (Mark 1 kit)

NBC	Nuclear, Biological, Chemical
NBCC	Nuclear, Biological, Chemical, Conventional
NBCD Cell	Nuclear, Biological, Chemical Defense Cell
Nuc	Nuclear
OCONUS	Outside Continental United States (Overseas)
OG	Overgarment
OPSEC	Operations Security
OPTEMPO	Operations Tempo (Sense of Urgency)
OSC	On Scene Commander
OSI	Office of Special Investigation (Also AFOSI)
PA	Public Affairs
PAR	Post-Attack Reconnaissance
Permethrin	Insect Repellent
PIN	Personal Identification Number
PL	Protection Level
POA	Power of Attorney
POW	Prisoner of War
PROWORDS	Procedure Words (Used for Radio Communication)
P-Tabs	Pyridostigmine Bromide (Nerve Agent Pretreatment for Soman)
Recon	Reconnaissance
ROE	Rules of Engagement
RST	Readiness Support Team or Religious Support Team
SABC	Self Aid and Buddy Care
S-A-L-U-T-E	Size, Activity, Location, Unit, Time, Equipment
SF	Security Forces
SOFA	Status of Forces Agreement
Split-MOPP	Concept of Dividing Base into CB Zones or Sectors
SRC	Survival Recovery Center
SSCRA	Soldiers and Sailors Civil Relief Act
SSS	Small Shelter System
TFA	Toxic Free Area
TIM	Toxic Industrial Material
UCC	Unit Control Center
UCMJ	Uniform Code of Military Justice
UGR	Unitized Group Ration
USERRA	Uniformed Services Employment and Re-employment Rights Act
UXO	Unexploded Ordnance
WOC	Wing Operations Center
Yd, yd	Yard or Yards

Index

- AFOSI 8,11,14, 16, 40, 41,
59, 73, Critical 26
- Alarm Black 126
- Alarm Blue 20, 92, 93
- Alarm Green 77, 78
- Alarm Yellow 79, 80
- Alarm Red 20, 78, 92, 93
- Ambush 44, 101
- Animals 44, 48, 142, 144
- Anthrax 143
- Arrival Actions 38, 40
- Atropine 146, Critical 10, 11
- Auto-injector 145, 146
- BDO 21, 22, 23, 24, 28,
29, 30, 31, 160, 161,
167, 169, 214
- Biological 20, 21, 27, 32, 56,
60, 61, 69, 84, 128,
132, 139, 141, 142,
144, 149, 152, 153,
159, 162, 168, 174
- Blackout 41, 63, 64
- Blister Agent 134, 137, 148
- BVO 23, 25, 215
- C2 Canister 21, 27, 40, 153, 154,
155, 156, 159, 160,
162, 163, 164, 167,
168, 169, 170, 207,
208, 209, 212
- Camouflage 43, 63, 64, 66
- Cargo Pallet 38, 40, 58, 67, 69,
- Chem/Bio 62, 63, 65, 114,
127, 168, 169, 182,
Critical 1
- CCA 23, 26, 41, 78, 132,
133, 158, 161, 165,
167, 173, 175, 216,
- CCP 176, 177, 185, 189,
Critical 1
- Chaplain 4, 11, 14, 38, 50,
190, 192
- Cold 5, 6, 32, 39, 46, 112,
147, 153, 161, 162,
166, 167, 168, 182,
187,
- Communications 39, 58, 71, 72, 79,
88, 90, 91, 95, 101,
139, 196, 197, 198
- COMSEC 72
- CONOPS 82
- Contaminated Waste 41, 56, 57, 67, 69,
78, 98, 114, 127, 175
- Contamination Avoidance 41, 56, 67, 69, 77,
78, 79, 80, 126, 145,
148
- Convoy 44, 82, 100, 101
- Cordon 75, 84, 131, 144
- CPO 21, 22, 24, 25, 26,
29, 30, 31, 156, 157,
158, 164, 165, 169,
214
- Decon 21, 32, 35, 51, 56,
68, 69, 77, 78, 98,
99, 114, 126, 127,
133, 138, 140, 143,
144, 145, 148, 171,
173, 174, 175, 216,
Critical 1, 9, 17
- DEET 48
- Defectors 89
- DFP 65, 66
- Diazepam 147, Critical 12
- Dispersal 41, 63, 71, 77, 80,
101, 140
- Drinking through Mask 171
- DU 140
- EOD 38, 73, 130, 216
- ECP 64, 84, 85
- EPW 14, 89, 90

Finance.....	2, 4, 11, 38	M295.....	32, 56, 98, 114, 127, 148, 171, 173, 174, 175, 177
Fire.....	21, 28, 29, 30, 31, 38, 40, 41, 52, 53, 54, 55, 56, 60, 61, 63, 65, 66, 78, 92, 100, 150, 152, 216, Critical 1, 16, 26	M45 Mask.....	21, 24, 162, 163, 164, 165, 166, 167, 168, 208, 210, 212
Flags.....	20, 91, 92, 93, 126	M8.....	21, 32, 35, 56, 65, 67, 68, 69, 77, 78, 98, 126, 127, 134, 135, 136, Critical 1
Flares.....	97	M9 Pistol.....	117, 118, Critical 25
FPCON.....	10, 19, 38, 40, 70, 91, 92	M9 Paper (Tape).....	21, 23, 26, 28, 32, 35, 40, 56, 78, 127, 137
Geneva Convention.....	13, 89, 190, 191, 192	Mark 1 Kit.....	146, 147, Critical 10, 11, 12,
Grid Map.....	95, 127, 129, 131, 218	Marking.....	23, 26, 27, 40, 57, 98, 127, 128, 131, 214, Critical 2
GVO.....	23, 215	MCU-2 Series Mask.....	21, 24, 153, 154, 156, 158, 159, 160, 161, 168, 206, 212
HAZMAT.....	150	Media.....	15, 16, 17
Heat.....	33, 41, 46, 51, 52, 53, 54, 60, 61, 67, 99, 138, 139, 150, 152, 153, 162, 182, 183, 185, 186, 216, Critical 8, 14, 16	Medical.....	4, 10, 11, 14, 38, 39, 41, 46, 47, 48, 50, 51, 70, 132, 142, 144, 145, 146, 148, 149, 176, 178, 179, 183, 184, 185, 186, 187, 190, 192, 216, Critical 12, 18, 19, 26
Human Remains.....	176, 189	Mobility Bag.....	5, 6, 10, 38, 39, 40
HVAC.....	67, 79, 150, 151, 152, Critical 14, 15, 16	MOPP 0.....	27, 77, 78, 79, 80
Hydration.....	40, 46, 171, 182, 183, 216	MOPP 1.....	26, 28, 79
Hygiene.....	6, 47, 141, 143	MOPP 2.....	26, 29, 79, 80,
IBD.....	82, 83	MOPP 3.....	30, 79
IED.....	42, 43, 44, 45, 74, 101	MOPP 4.....	26, 31, 79, 88, 92, 93, 126, 145, 148, 216
Insects.....	6, 48, 55, 56, 144	MOPP Options.....	27, 32, 33
IPE.....	10, 21, 27, 32, 33, 39, 40, 46, 56, 77, 78, 79, 89, 94, 99, 132, 145, 148, 173	MULO.....	23, 25
JFIRE.....	21, 28, 29, 30, 31		
JSLIST.....	21		
Legal.....	2, 3, 4, 8, 11, 18, 39		
LOAC.....	12, 13, 14, 18		
M16.....	103, 107, 110, 111, Critical 24		

NBC.....	10, 27, 28, 29, 30, 31, 32, 41, 54, 57, 63, 67, 69, 78, 90, 93, 99, 114, 126, 127, 132, 177, 189, 216	132, 138, 149, 150, 151, 176, Critical 8, 13, 14, 15, 16, 26
Nerve Agent.....	32, 40, 41, 134, 135, 136, 145, 146, 147, 177, Critical 10, 11, 12	Smallpox..... 143
Nuclear.....	20, 21, 27, 32, 60, 61, 84, 138, 139, 140, 149, Critical 8, 9	Split-MOPP..... 34, 35, 71, 77, 91, 92, 177
OPSEC.....	16, 96	SRC..... 41, 70, 127, 129, 131, Critical 3, 26
Permethrin.....	48	SSS..... 51
Public Affairs.....	8, 16, 17	Supply..... 39, 48, 212
Plague.....	143	Take Cover..... 92, 98, 150, Critical 13
POW.....	190, 191, 192, 193	TEMPER..... 51
PROWORDS.....	96, 196, 197	Tent..... 41, 51, 53, 55, 176
Readiness.....	10, 20, 59, 77	Terrorist..... 19, 42, 73, 74, 75, 140, 142
Recon.....	33, 41, 77, 83, 125, 126, 216, Critical 9	TFA..... 133
Roadblock.....	101	Threat..... 10, 13, 19, 20, 27, 32, 33, 34, 38, 40, 42, 45, 46, 48, 60, 61, 62, 63, 64, 65, 67, 69, 72, 73, 74, 75, 77, 82, 83, 84, 91, 93, 100, 101, 142, 143, 151, 168, 176, 191
ROE.....	12, 93	TIM..... 149
SABC.....	41, 78, 126, 176, 177, Critical 1, 9, 13	UCC..... 30, 34, 35, 41, 71, 73, 77, 78, 86, 87, 90, 93, 98, 99, 100, 101, 126, 127, 129, 131, 134, 173, 177, Critical 1, 2, 3, 14, 16, 17, 26
Safety.....	36, 38, 40, 42, 52, 55, 97, 102, 117, 118, 121, 122, 146, Critical 10, 11, 25	UCMJ..... 18
S-A-L-U-T-E.....	87, 93, 95, 100, 101, Critical 1	UXO..... 40, 45, 74, 78, 126, 128, 129, 130, 131, Critical 1, 2, 3, 4, 5, 6, 7
Search.....	76, 89, 216	Waste..... 41, 55, 56, 57, 67, 69, 78, 98, 114, 127, 175
Security Forces.....	40, 41, 59, 72, 73, 76, 84, 86, 87, 88, 89, 92, 93, 152, Critical 16, 26	
Second Skin.....	21, 40, 153, 162, 169, 170, 208, 209	
Services.....	38, 39, 58, 80	
Shelter.....	38, 41, 51, 68, 71, 77, 78, 79, 80, 91, 92, 94, 98, 126, 130,	

NOTES



#2 pencil works best

NOTES

NOTES

#2 pencil works best

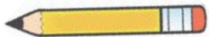

NOTES

AFMAN 10-100

CRITICAL INFORMATION CHECKLIST

Be ready for the challenge.



U.S. AIR FORCE

Critical Information Checklist

Post Attack Actions	1
UXO Survey	2
USAF Unexploded Ordnance (UXO) Recognition and Reporting Chart ...	3
Nuclear Attack Radioactive Individual Protective Actions	8
Nerve Agent Poisoning and Antidote	10
Shelter In-Place Actions	13
Life Saving Steps	17
Shock	18
Tourniquet	19
Abdominal Wound	20
Bleeding	20
Common Injury Treatment	21
Spinal/Neck/Head Injury	21
Eye Injury	22
Chest Wound	22
Fracture	23
M16 Jammed	24
M9 Jammed	25
Important Phone Numbers and Quick Reference	26

Post-Attack Actions

- S-A-L-U-T-E (ground attack)
- SABC self/buddy
- Decon self/buddy
- Listen for Chem/Bio alarms
- Listen for people who need help
- Survey:
 - Damage/fires -Facilities -Vehicles
 - Equipment -Aircraft -Routes
 - M8 Paper
- Survey area for UXO—mark UXO
- Report to UCC
 - UXO location(s) -Damage/fire(s)
 - M8 Paper -Casualties
- Transport casualties to CCP
- Fight fires
- Maintain UCC contact
- Request help if needed
- Continue mission

Read M8 Paper with white light only!

CRITICAL

Post-Attack 1

die cut around tab

UXO Survey

Follow **UXO 4-R's: Recognize, Record, Retreat, Report**



DO NOT...

- Touch or attempt to extinguish
- Move closer
- Transmit handheld radio within 25 ft
- Transmit vehicle radio within 100 ft



DO...

- Approach from UPWIND or CROSSWIND
- Recognize by CLASS, SHAPE, SIZE
- Remember FEATURES, COLORS, MARKINGS
- Mark UXO
- Depart UPWIND or CROSSWIND
- Mark or barricade approach routes
- Report to UCC when safe

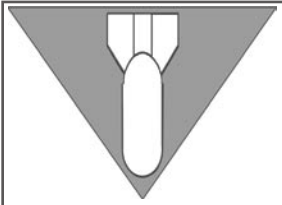

USAF Unexploded Ordnance (UXO) Recognition and Reporting Chart

Report to UCC or SRC

- Location, cordon size, how UXO is marked, and distance between UXO and marker
- Class or shape (i.e. Bravo 1)
- UXO features
- UXO condition (leaking? intact? broken?)
- Other information

BLOCK APPROACH AVENUES

CRITICAL

CRITICAL

Class A: Large Bombs



A1, Bomb, 3-8 ft



A2, bomb, 3-8 feet



A3, bomb, 3-8 feet



A4, bomb, 5-6 feet

Class B: Rockets, Missiles



**B1, missile,
6-20 feet**



**B2, rocket,
6-20 feet**

12 Inch Ruler

Class C: Projectiles, Mortars

C1

PROJECTILES



C2

C3

C4

C5

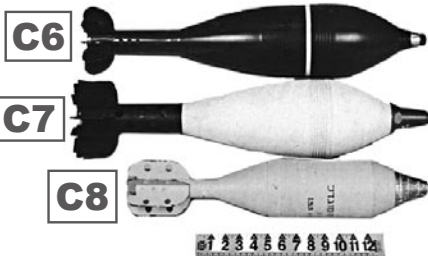

C6

C7

C8

CRITICAL

die cut around tab

UXO Chart 5

CRITICAL

MORTARS



Class D: Landmines

Class E:
Bomblets

E1

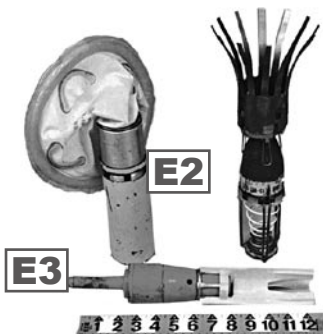



Class F: Rocket Propelled Grenades, Grenades



RPGs

GRENADES



CRITICAL

Nuclear Attack Radioactive Individual Protective Actions

INITIAL ACTIONS

Advanced warning:

- Find shelter that provides greatest protection
- Use window barriers and shielding to improve protection
- Upon seeing nuclear flash, seek protection from blast wave, heat, and flying debris

If a detonation occurs without warning:

- Drop to a prone position
- Cover eyes and face
- DO NOT move until initial and any reflected blast waves pass

FOLLOW-ON ACTIONS

- Stay under cover until directed otherwise
- Perform SABC
- Perform post-attack recon when released
- Decon yourself
 - Brush dust/fallout off clothing
 - Blot away with adhesive tape
 - Rinse exposed skin
- Limit radiation exposure by using:
 - Time
 - Distance
 - Shielding

CRITICAL

CRITICAL

Nerve Agent Poisoning and Antidote

Self Administer or Administer for Casualty (Use casualty's antidote on casualty—not yours!)

1. Don mask (place mask on casualty)
2. Observe for SYMPTOMS
 - Dimming vision
 - sweating
 - Pinpointed pupils
 - Runny nose
 - Unconsciousness
 - Diarrhea
 - Muscles twitching
 - Seizures

When Symptoms are Present:

1. Remove one Atropine injector (Small Injector) from Mark-1 Kit



2. Remove safety cap
3. Place needle end of injector on injector site

4. Press firmly until needle triggers
5. Hold In place for 10 seconds
6. Remove injector
7. Bend needle to form a hook
8. Hang injector from your or casualty's pocket
9. Remove one 2-Pam Chloride (large injector) from Mark-1 Kit



10. Remove safety cap
11. Repeat same steps as Atropine injector

WARNING: DO NOT inject second Mark-1 Kit if within 5-10 minutes:

- Heart beats very quickly
- Mouth becomes dry

CRITICAL

die cut around tab

Nerve Agent 11

CRITICAL

MILD SYMPTOMS: If mild symptoms persist AFTER 10-15 MINUTES, inject second Mark-1 Kit (use buddy) seek medical help

SEVERE SYMPTOMS: Administer ALL THREE Mark-1 Kits followed by Diazepam injector to prevent convulsions—DO NOT WAIT between injecting Mark-1 Kits

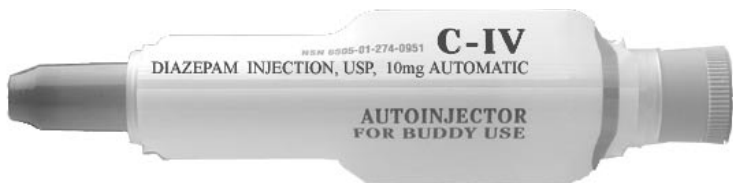

WARNING: DO NOT use more than three Mark-1 Kits. Use Diazepam ONLY after all three Mark-1 Kits have been administered.

Shelter In-Place Actions

Outdoor Hazard While You're Outside a Building

- Take cover
- Notify others
- Don protective equipment
- Report the hazard
- Perform SABC
- Seek nearest building or safest area
- Shelter-in-place until otherwise directed
- Follow shelter or facility manager instructions

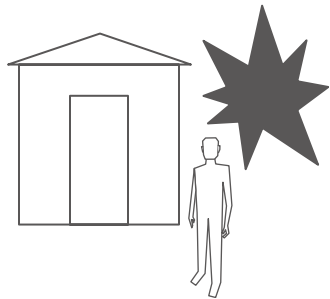

Outdoor Hazard While You're Inside a Building (same as outdoor hazard while you're outside a building plus...)

- Turn off:
 - HVAC
 - Fans and exhaust fan(s)
 - Combustion heaters
- Secure classified material
- Move to a central safe room or area or evacuate upwind or crosswind (if directed)
- Notify UCC after hazard passes
- Purge and ventilate buildings when directed:
 - Open windows and doors
 - Turn-on smoke and exhaust fans
 - Turn-on HVAC air handlers and fans

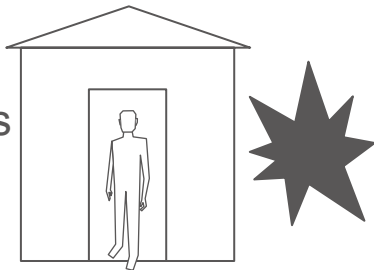

Outdoor Hazard While You're Inside an Expeditionary or Temporary Structure

- Operate HVAC systems including window units in closed or recirculation mode
- If a release warning is provided, follow previous guidelines

If you're aboard an aircraft:

- Aircrew actions (before or after taxiing) include closing hatches, windows, and using oxygen masks (if available)
- Passengers might evacuate aircraft as required by situation

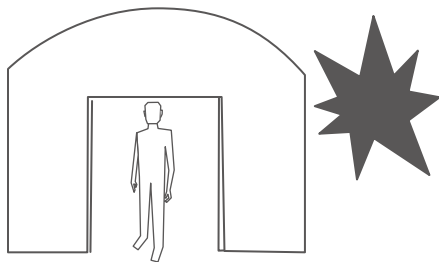

Shelter In-Place

CRITICAL

Inside hazard while you're inside the building (same as outdoor hazard while you're outside a building plus...)

- Turn off:
 - HVAC
 - Fans and exhaust fan(s)
 - Combustion heaters
- Report incident to Fire Services or Security Forces
- Close and seal doors and windows to contain hazard
- Secure classified material
- Evacuate upwind or crosswind
- Notify UCC

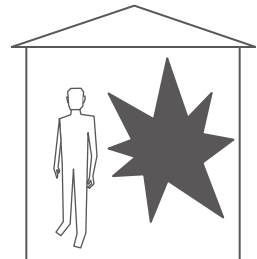

Life Saving Steps

Perform Self-Aid and Buddy Care

- Open **Airway** (possible neck injury, use jaw thrust maneuver, DO NOT turn head)
- Ensure **Breathing**
- Support **Circulation** (stop bleeding) immobilize neck injuries
- Prevent further **Disability** (place dressings over open wounds and splint obvious limb deformities)
- Minimize further **Exposure** to adverse weather

For Chemical Environment Casualty

- Place mask on casualty
- Decon casualty as needed using casualty's decon kits
- Report casualty to UCC
- Ambulances DO NOT run during/ following attacks
- Follow UCC instructions for transport to CCP
- Watch for chemical agent symptoms

CRITICAL

die cut around tab

CRITICAL

Shock

Shock Symptoms:

- Confusion
- Sweaty but cool skin (clammy skin)
- Shallow, labored-and-rapid breath
- Weak-rapid pulse

Shock Treatment:

- Keep airway open
- If unconscious, place on side in recovery position, monitor airway
- Keep person calm, warm, and comfortable
- Elevate lower extremities
- Seek medical attention
- Do not give food or drink

Tourniquet

WARNING: Never use a tourniquet unless there is danger to life. Use tourniquet only as last resort to stop bleeding to save life at possible loss of limb! Never remove a tourniquet—it must be removed by medical personnel only!

- Place one-inch wide constricting band around arm or leg to stop severe bleeding—DO NOT use wire or shoestrings
- Place band 2-4 inches above injury if possible
- Tighten band enough to stop bleeding—no more than is necessary!
- Once in place do not loosen or remove
- Expose tourniquet area for quick visual reference
- Mark time and letter “T” on casualty’s forehead (ink or blood)

CRITICAL

die cut around tab

20 Abdominal, Bleeding

die cut around tab

CRITICAL

Abdominal Wound Treatment:

- If organs are outside body, gently pick them up and place them on top of abdomen—do not replace or push organs into body
- Cover exposed organs with moist clean dressing
- Secure with bandages
- If legs are not fractured bend knees to relieve pressure

Bleeding Treatment:

- Apply direct pressure with hand (Use dressing if available)
- Elevate extremity if no fractures are suspected
- Use pressure points to control bleeding
- DO NOT remove old dressing
- Add more dressing over old (if needed)

Common Injury Treatment

Spinal/Neck/Head Injury Symptoms:

- Lack of feeling and/or control anywhere below neck, drainage of fluid or blood from ear, nose, or mouth

Treatment:

- If conscious, caution casualty not to move
- Continuously monitor and check airway without turning casualty's head
- Immobilize head and neck
- If casualty must be moved:
 - Use hard surface for litter (door, cut lumber, other)
 - Use as many people as needed to place casualty on litter
 - Immobilize head and neck
- Ensure casualty's limbs are secured at chest and thigh regions
 - Turn/rotate whole body as a unit

DO NOT Bend Spinal Cord
DO NOT Rotate Head and Neck

Common Injury

CRITICAL

Eye Injury Treatment:

- DO NOT remove impaled objects
- Secure objects with clean dressing
- Apply bandage lightly to BOTH eyes
- DO NOT leave casualty unattended

Chest Wound Symptoms:

- Sucking noise from chest
- Frothy red blood from wound

Treatment:

- Look for entry and exit wound
- Cover holes with airtight seal (tin foil, ID card)
- Tape down seal on 3 sides—leave bottom uncovered
- Let casualty assume position for easiest breathing (preferably on affected side)

Fracture Symptoms:

- Deformity, bruising
- Tenderness over specific part of body
- Swelling/discoloration

Treatment:

- DO NOT straighten limb
- If in doubt, splint injury where they lie (if possible)
- Splint joints above and below injury
- Remove clothing from injured area
- Remove rings from fingers (if possible)
- Check pulse below injury—away from heart to determine if blood flow is restricted

CRITICAL

**Common
Injury**

23

M16 Jammed

CRITICAL

M16A2 Procedures:

(If the weapon fails to fire)

- **S**lap upward on bottom of magazine to ensure magazine is fully seated
- **P**ull charging handle to rear
- **O**bserve to see if a round or cartridge casing was ejected and chamber/ receiver area are clear (proceed to remedial action if chamber isn't clear)
- **R**elease charging handle (allow bolt to slam forward)
- **T**ap forward assist button to ensure bolt is fully forward
- **S**hoot

M16A2 Remedial Action:

(If above actions do not correct problem, or an obstruction is found)

- Clear weapon
- Check again for jammed cartridge case. NOTE: Inspect closely... a ruptured cartridge case can be difficult to see
- If cartridge case is detected, use a cleaning rod to remove

- Reload weapon
 - Select Semi
 - Fire
-

M9 Procedures:

(If weapon fails to fire)

- Ensure decocking /safety lever is in the fire position (up)
- Smack upward on bottom of magazine to ensure it is fully seated
- Rack the slide to the rear and release
- Fire

M9 Remedial Action Procedures:

(If above actions do not correct problem)

- Remove magazine
- Eject chambered round
- Insert new magazine
- Rack slide to rear and release to chamber new round
- Attempt to fire
- If pistol still does not fire, replace ammunition

CRITICAL

Important Phone Numbers and Quick Reference

	Phone #	Building #
UCC _____		
Alternate UCC _____		
WOC _____		
Command Post _____		
SRC _____		
Work Center _____		
Security Forces _____		
AFOSI _____		
Fire, 911 or different _____		
Casualty Collection Point _____		
Medical Clinic _____		
My Shelter _____		
Alternate Shelter _____		
Billeting _____		

Bed # _____

Radio Call Signs—My Call Sign: _____

Dining Facility: Phone # _____ Bldg # _____

Operating Hours: Breakfast _____

Lunch _____

Dinner _____

Midnight _____